

1.
FLAT
PERGOLAS
WITH BLADES



Scheda tecnica di Pre-Installazione
Pre-Installation technical sheet
Fiche technique de pre-installation
Vorinstallationsblatt

[Dimensioni in cm]
[Dimension in cm]
[Dimensions cm]
[Abmessungen in cm]

IT - È possibile scaricare la versione più recente di questo documento dal nostro portale B2B (effettuare una scansione del codice QR qui riportato o andare direttamente sul sito <https://b2b.pratic.it/login.jsf>). La Pratic considera questo documento come riservato e destinato al solo installatore del prodotto a cui il documento stesso è associato. La Pratic specifica, inoltre, che il presente documento viene fornito a solo scopo illustrativo ai fini del montaggio e/o della manutenzione del prodotto a cui questo documento è associato attraverso il nome commerciale del modello. È vietato qualsiasi utilizzo di questo documento a fini differenti da quelli indicati, così come la riproduzione e/o la divulgazione, anche parziale, a terzi, senza l'autorizzazione scritta specifica della Direzione della Pratic.

EN - You can download the latest version of this document from our B2B portal (scan the QR code here indicated or go directly to the website <https://b2b.pratic.it/login.jsf>). Pratic considers this document confidential and for the exclusive use of the installer of the product (to which the document is linked). Pratic also specifies that this document is provided for illustrative purpose only for the assembly and/or the maintenance of the product to which this document is linked by the commercial name of the model. Any use of this document for different purposes from those indicated is forbidden, as well as the reproduction and/or disclosure, even partial, to third parties, without the specific written authorization of Pratic management.

FR - On peut télécharger la dernière mise à jour de ce document depuis notre portail B2B (scannez le QR code ci-indiqué ou allez directement sur le site <https://b2b.pratic.it/login.jsf>). La société Pratic considère ce document comme confidentiel et d'utilisation exclusive de l'installateur du produit auquel le document même est lié. La Pratic spécifie aussi que ce document est fourni à seul titre d'illustration pour le montage et/ou l'entretien du produit auquel ce document est lié par le nom commercial du modèle. Toute utilisation de ce document à des fins autres que celles indiquées est interdite, ainsi que la reproduction et/ou la divulgation, même partielle, à des tiers, sans l'autorisation spécifique par écrit de la Direction de la Pratic.

DE - Sie können die aktuellste Version diese Dokuments von unserem B2B Portal herunterladen (scannen Sie den hier abgebildeten QR-Code oder gehen Sie direkt auf die Webseite <https://b2b.pratic.it/login.jsf>). Die Firma Pratic betrachtet dieses Dokument als vertraulich und es ist nur für den Installateur des Produkts bestimmt, mit dem das Dokument verbunden ist. Des Weiteren, erklärt die Firma Pratic, dass dieses Dokument nur zu Illustrationszwecken bereitgestellt wird. Zwecke in Hinblick auf die Montage bzw. Wartung des Produkts, dem dieses Dokument zugeordnet ist, über den geschäftlichen Name des Modells. Es ist verboten, dieses Dokument für andere als die angegebenen Zwecke zu verwenden, sowie für die teilweise Vervielfältigung bzw. Verbreitung an Dritten ohne ausdrückliche schriftliche Genehmigung der Geschäftsführung der Firma Pratic.



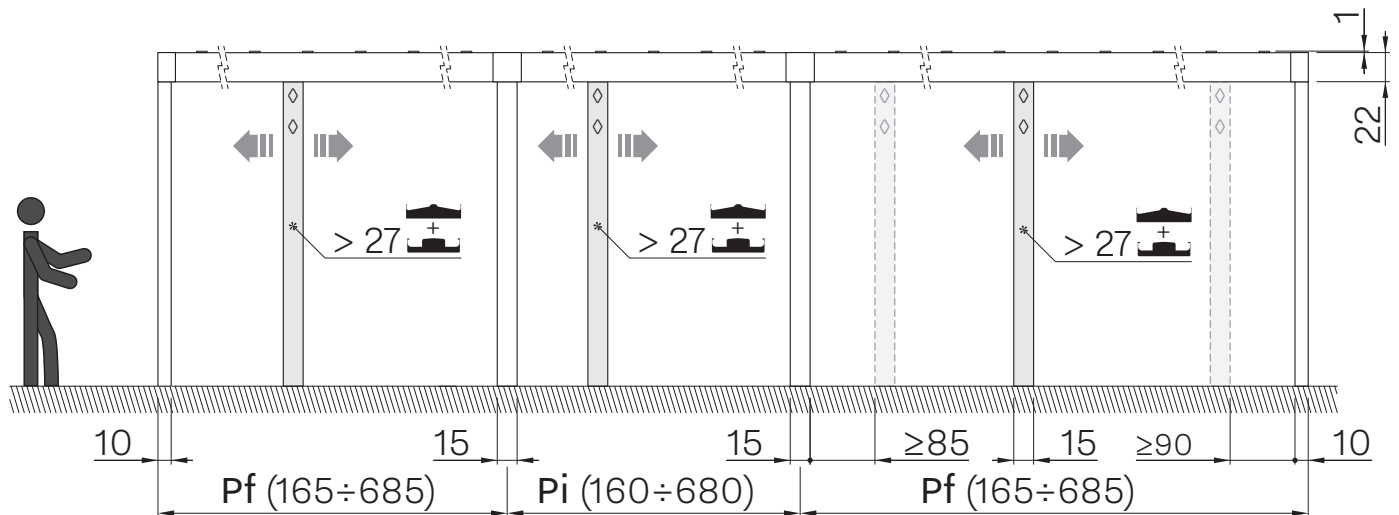
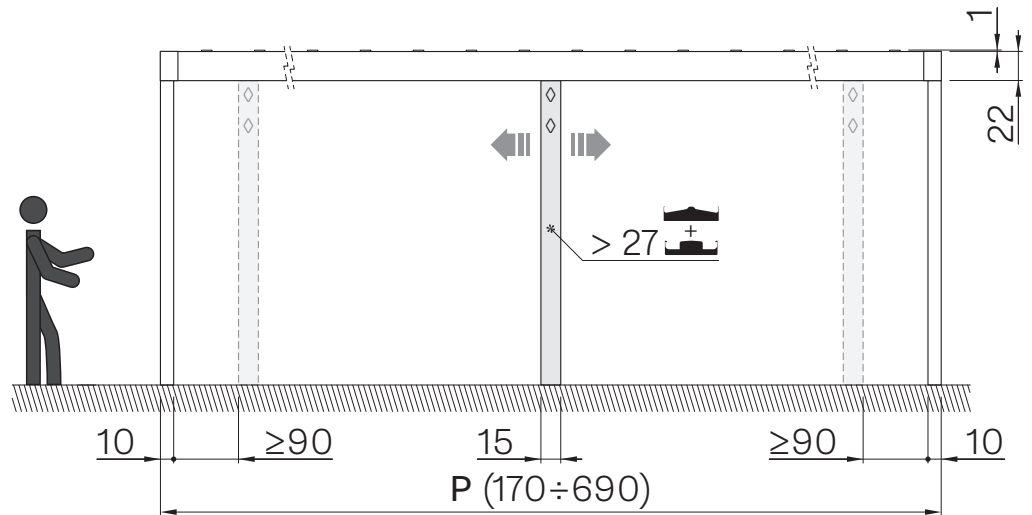
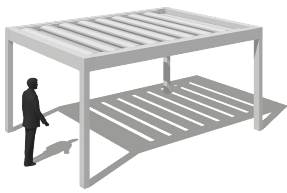
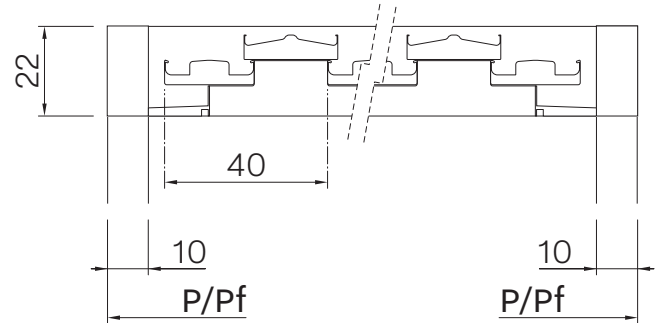
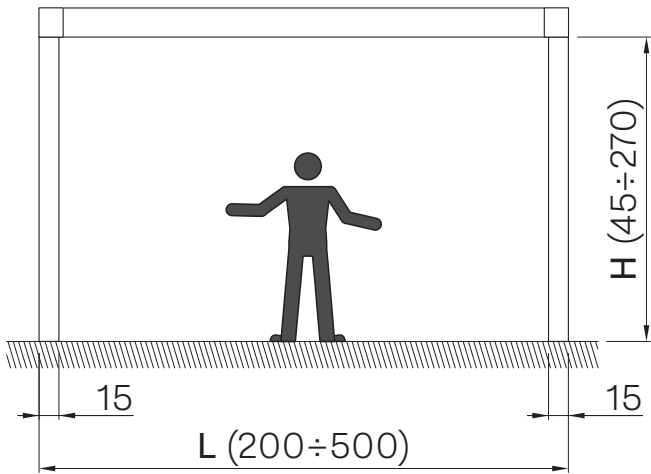

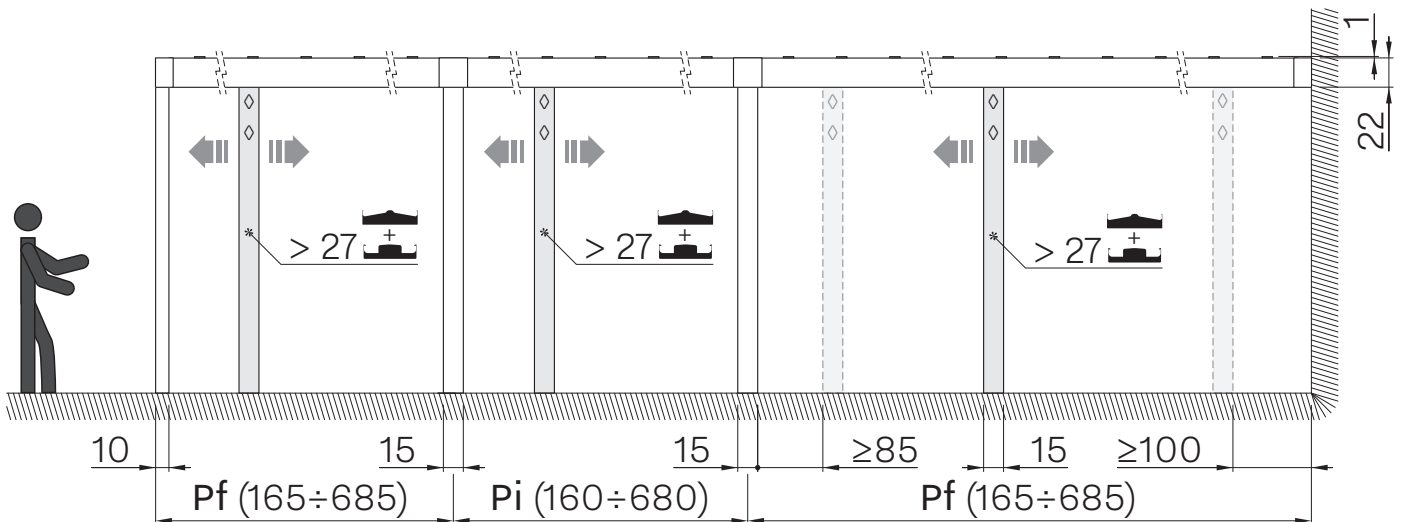
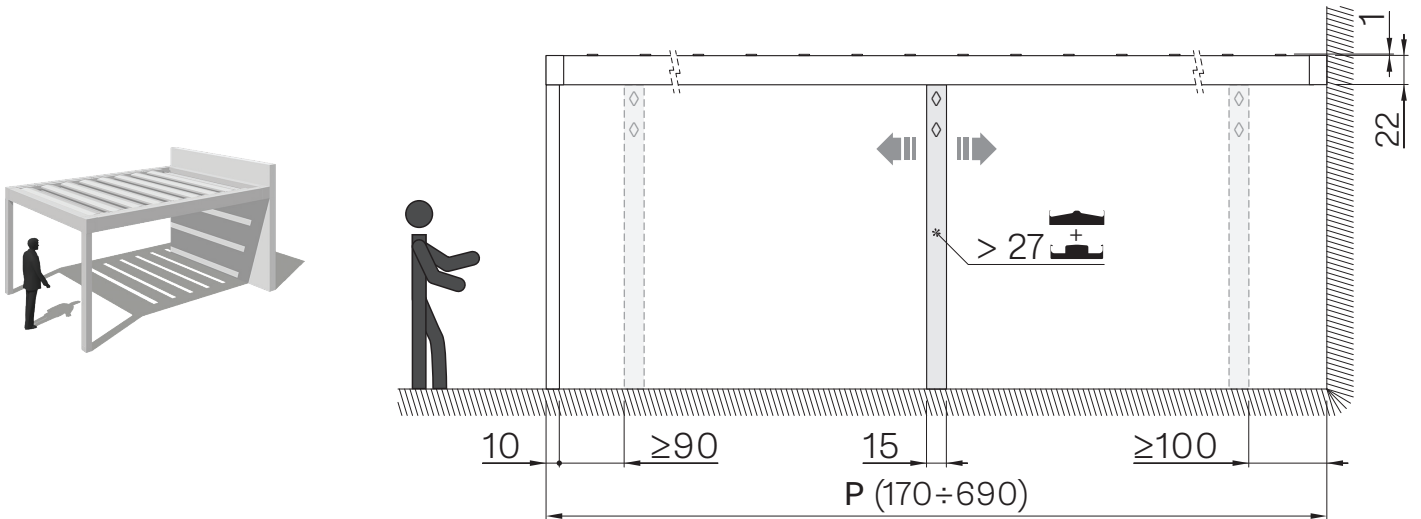
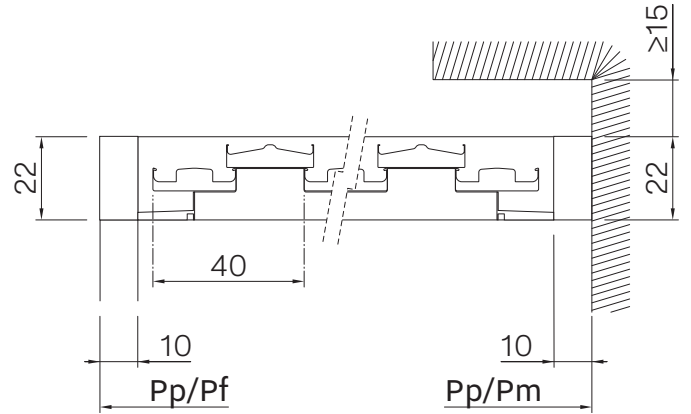
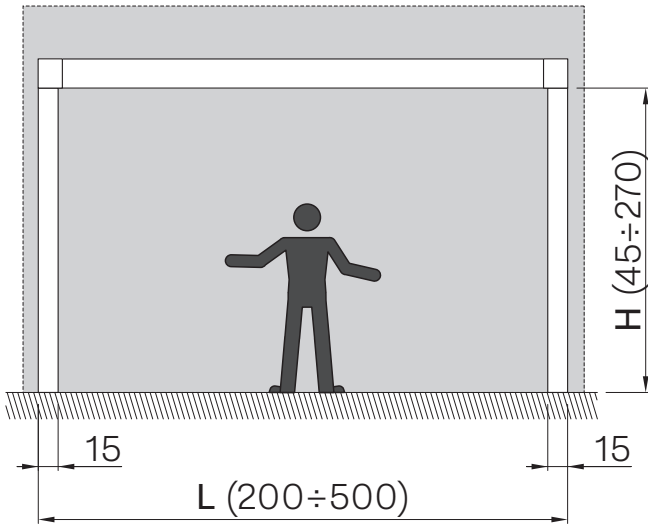

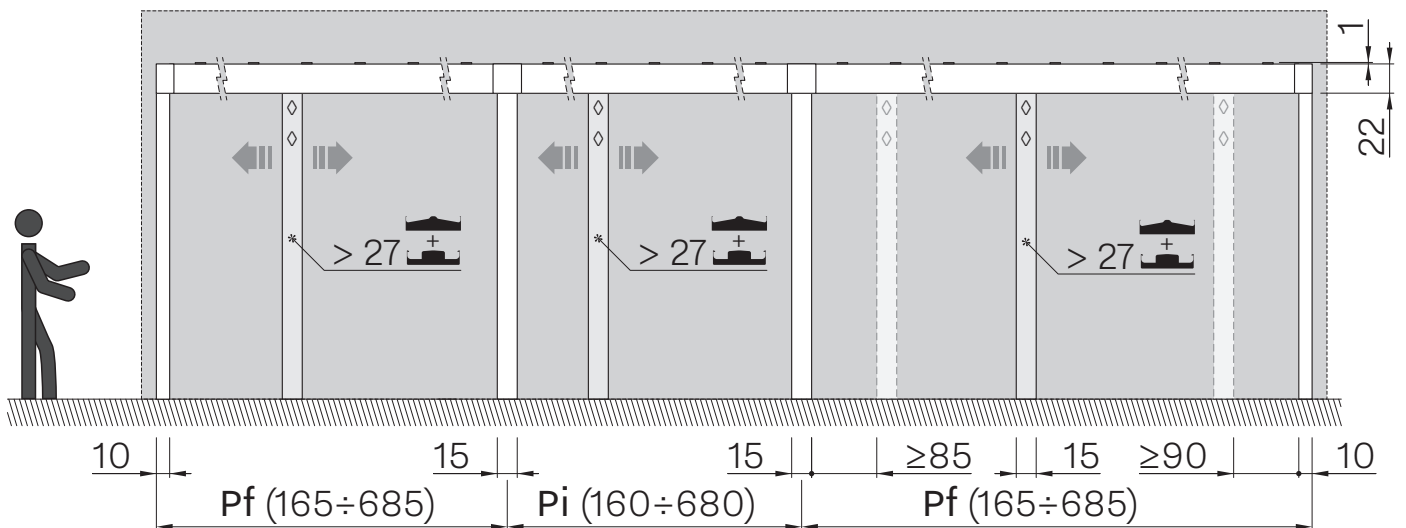
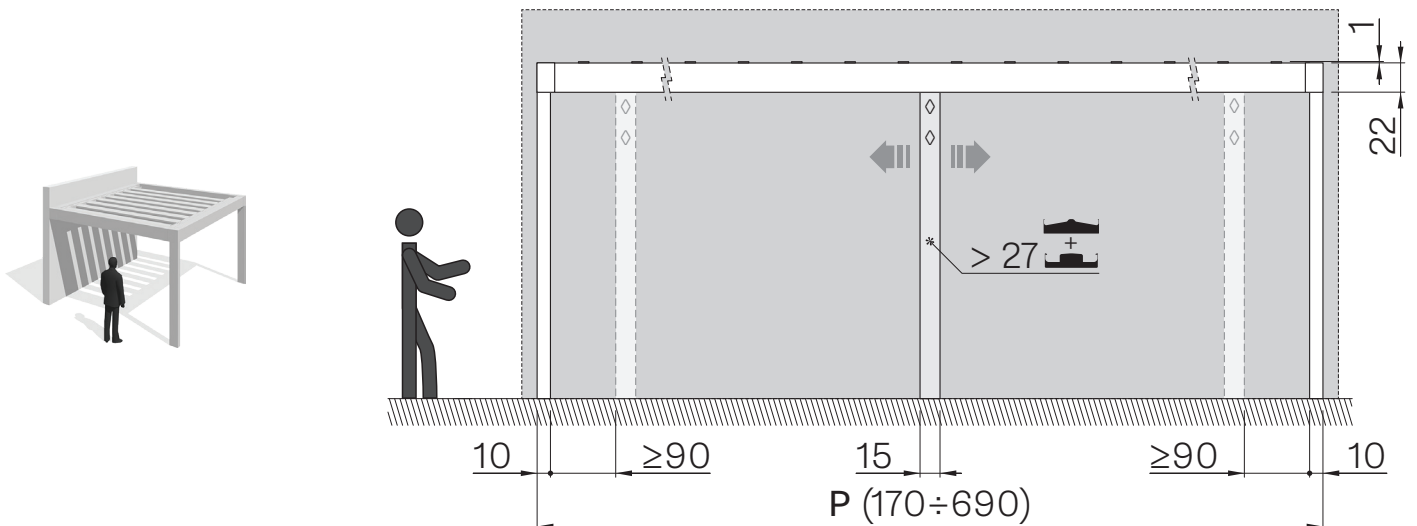
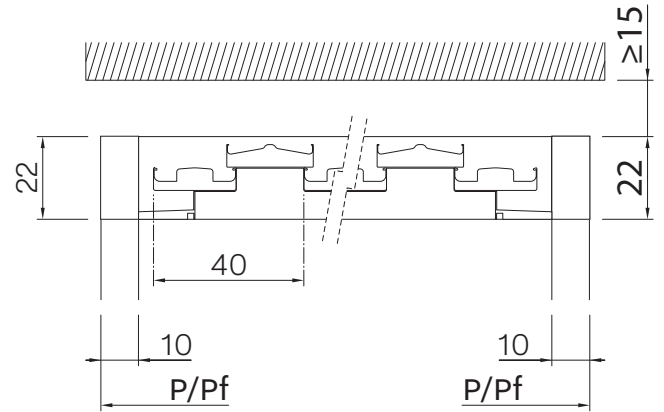
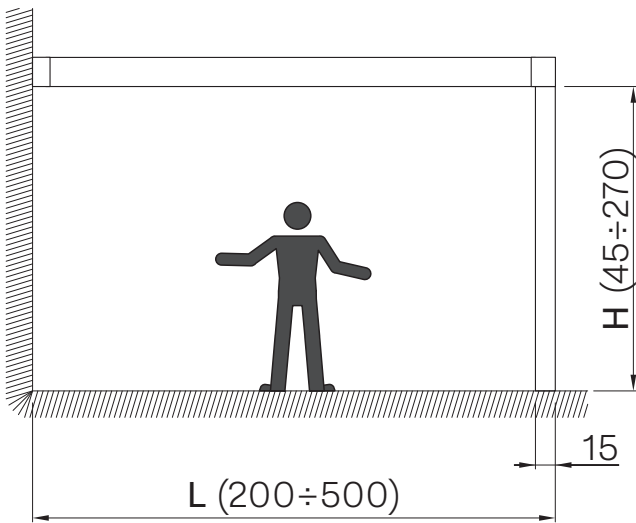

Dettagli tecnici
Détails techniques

Profilo portante (lato larghezza)
Supporting profile (width side)
Profilé porteur (côté largeur)
Trägerprofil (Seite der Breite)

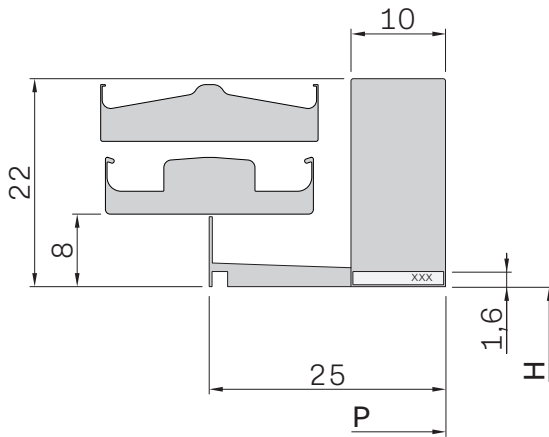

Technical details
Technische Daten



Profilo portante (lato profondità)
Supporting profile (depth side)
Profilé porteur (côté profondeur)
Trägerprofil (Seite Tiefe)

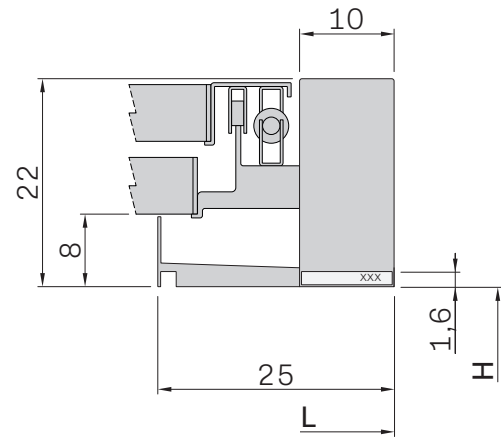

Profilo portante intermedio (Lato larghezza)
Intermediate supporting profile (Width side)
Profilé porteur intermédiaire (Côté largeur)
Mittleres Trägerprofil (Seite Breite)

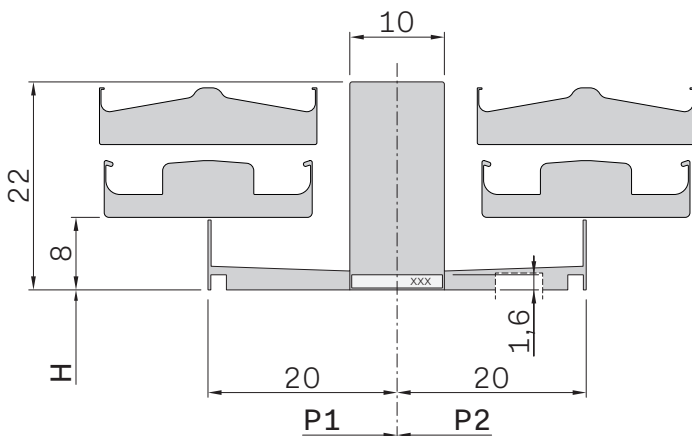

Profilo portante intermedio (Lato profondità)
Intermediate supporting profile (Depth side)
Profilé porteur intermédiaire (Côté profondeur)
Mittleres Trägerprofil (Seite Tiefe)

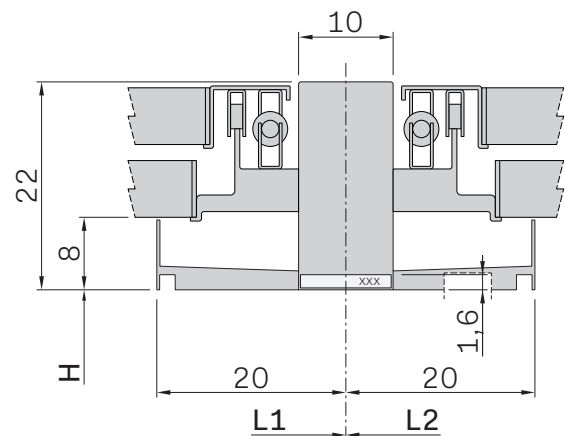

xxx

Intercapedine per fissaggio chiusure perimetrali
Hollow wall for fixation of peripheral closures
Interstice pour la fixation des fermetures laterales
Zwischenraum zur Befestigung der Umlaufenden Schließungen



Dettagli tecnici
Détails techniques

Fissaggio a muro con profilo (Lato larghezza)
Wall mounting with profile (Width side)
Fixation murale avec profilé (Côté largeur)
Wandmontage mit Profil (Seite Breite)



02

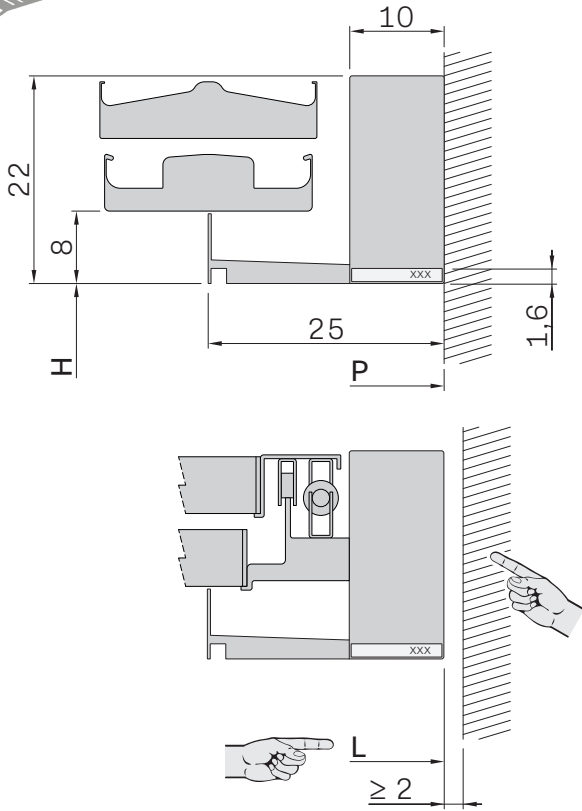

Profilo lama fissa
Fix blade profile
Profil lame fixe
Festes Lamellenprofil

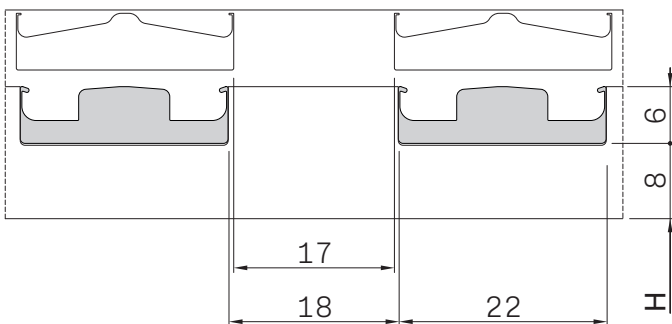

Technical details
Technische Daten

Fissaggio a muro con profilo (Lato profondità)
Wall mounting with profile (Depth side)
Fixation murale avec profilé (Côté profondeur)
Wandmontage mit Profil (Seite Tiefe)



03

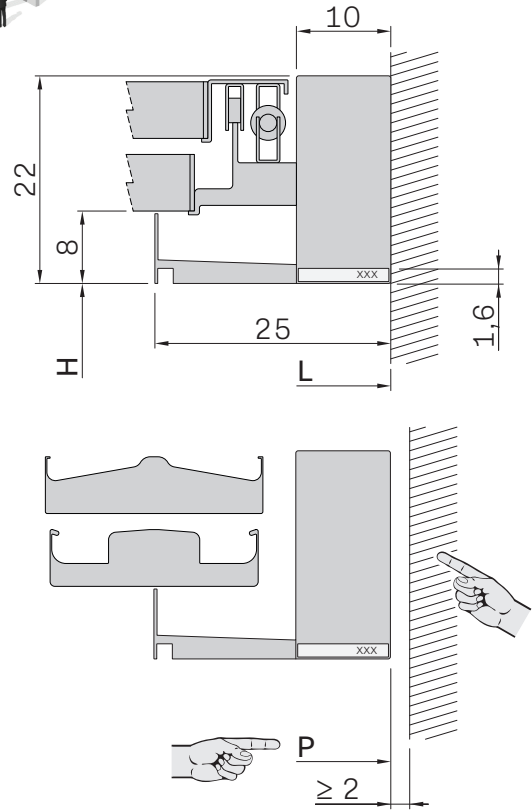

Profilo lama mobile
Mobile blade profile
Profil lame mobile
Mobiles Lamellenprofil

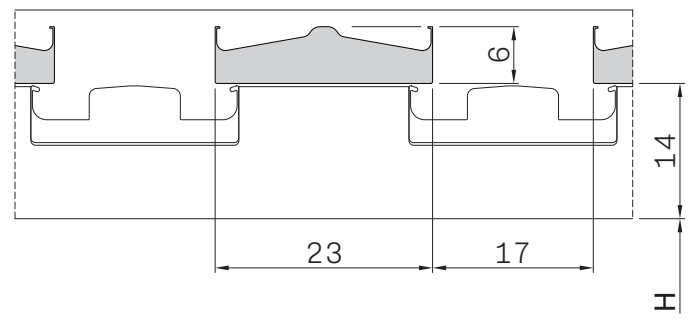

xxx
Intercapedine per fissaggio chiusure perimetrali
Hollow wall for fixation of peripheral closures
Interstice pour la fixation des fermetures laterales
Zwischenraum zur Befestigung der Umlaufenden Schließungen



Profilo compensatore profondità (ΔP/2 sulla prima e sull'ultima lama)
Depth compensating profile (ΔP/2 on first and last blade)
Profil de compensation profondeur (ΔP/2 sur la première et la dernière lame)
Tiefenausgleichsprofil (ΔP/2 am erste und letzte Lamelle)

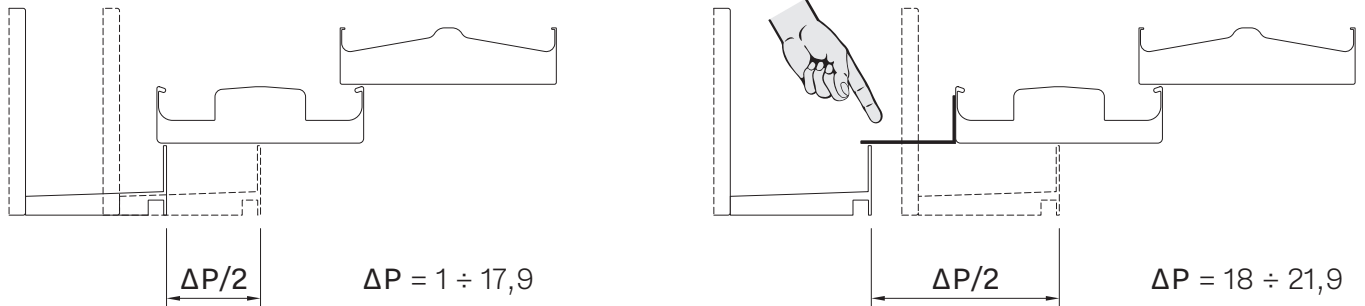

Profondità / Depth / Tiefe / Profondeur			ΔP			
P	Pf	Pi				
170 ÷ 187,9	165 ÷ 182,9	160 ÷ 177,9	1 ÷ 17,9		7	
188 ÷ 209,9	183 ÷ 204,9	178 ÷ 199,9	18 ÷ 21,9		7	
210 ÷ 227,9	205 ÷ 222,9	200 ÷ 217,9	1 ÷ 17,9		9	
228 ÷ 249,9	223 ÷ 244,9	218 ÷ 239,9	18 ÷ 21,9		9	
250 ÷ 267,9	245 ÷ 262,9	240 ÷ 257,9	1 ÷ 17,9		11	
268 ÷ 289,9	263 ÷ 284,9	258 ÷ 279,9	18 ÷ 21,9		11	
290 ÷ 307,9	285 ÷ 302,9	280 ÷ 297,9	1 ÷ 17,9		13	
308 ÷ 329,9	303 ÷ 324,9	298 ÷ 319,9	18 ÷ 21,9		13	
330 ÷ 347,9	325 ÷ 342,9	320 ÷ 337,9	1 ÷ 17,9		15	
348 ÷ 369,9	343 ÷ 364,9	338 ÷ 359,9	18 ÷ 21,9		15	
370 ÷ 387,9	365 ÷ 382,9	360 ÷ 377,9	1 ÷ 17,9		17	
388 ÷ 409,9	383 ÷ 404,9	378 ÷ 399,9	18 ÷ 21,9		17	
410 ÷ 427,9	405 ÷ 422,9	400 ÷ 417,9	1 ÷ 17,9		19	
428 ÷ 449,9	423 ÷ 444,9	418 ÷ 439,9	18 ÷ 21,9		19	
450 ÷ 467,9	445 ÷ 462,9	440 ÷ 457,9	1 ÷ 17,9		21	
468 ÷ 489,9	463 ÷ 484,9	458 ÷ 479,9	18 ÷ 21,9		21	
490 ÷ 507,9	485 ÷ 502,9	480 ÷ 497,9	1 ÷ 17,9		23	
508 ÷ 529,9	503 ÷ 524,9	498 ÷ 519,9	18 ÷ 21,9		23	
530 ÷ 547,9	525 ÷ 542,9	520 ÷ 537,9	1 ÷ 17,9		25	
548 ÷ 569,9	543 ÷ 564,9	538 ÷ 559,9	18 ÷ 21,9		25	
570 ÷ 587,9	565 ÷ 582,9	560 ÷ 577,9	1 ÷ 17,9		27	
588 ÷ 609,9	583 ÷ 604,9	578 ÷ 599,9	18 ÷ 21,9		27	
610 ÷ 627,9	605 ÷ 622,9	600 ÷ 617,9	1 ÷ 17,9		29	
628 ÷ 649,9	623 ÷ 644,9	618 ÷ 639,9	18 ÷ 21,9		29	
650 ÷ 667,9	645 ÷ 662,9	640 ÷ 657,9	1 ÷ 17,9		31	
668 ÷ 689,9	663 ÷ 684,9	658 ÷ 679,9	18 ÷ 21,9		31	
690	685	680			33	

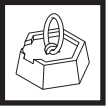

Peso massimo applicabile alle lame fisse
Poids maximal applicable aux lames fixes

Maximum applicable weight for fixed blades
Höchstzulässiges Gewicht auf den festen Lamellen

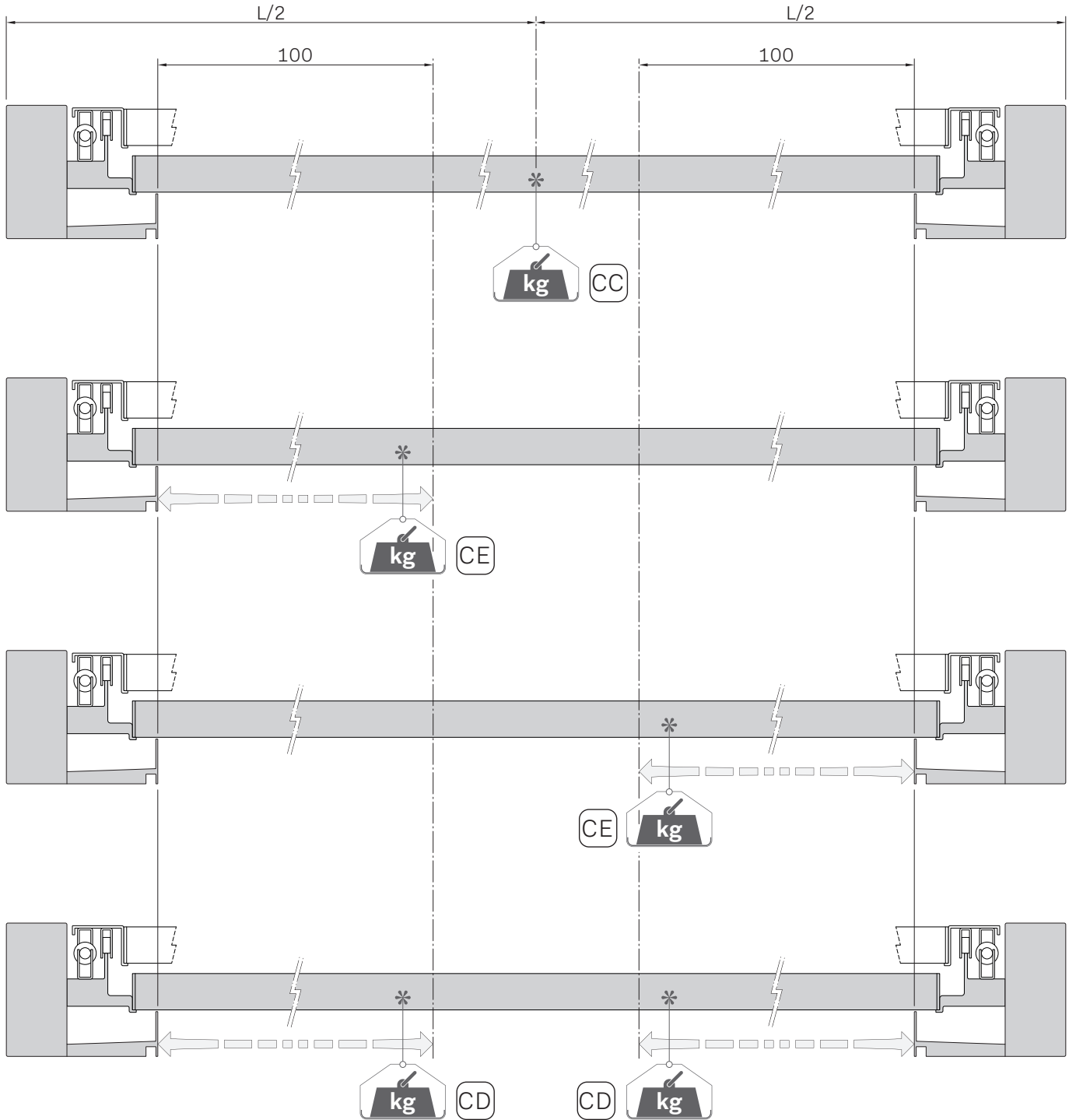

	L [Larghezza / Width / Largeur/ Breite]					
	250	300	350	400	450	500
CC	6 kg	6 kg	6 kg	6 kg	4 kg	4 kg
CE	8 kg	8 kg	8 kg	8 kg	7 kg	6 kg
CD + CD	3 kg + 3 kg	3 kg + 3 kg	3 kg + 3 kg	3 kg + 3 kg	2,5 kg + 2,5 kg	2,5 kg + 2,5 kg

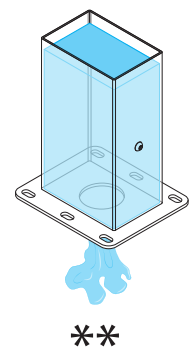
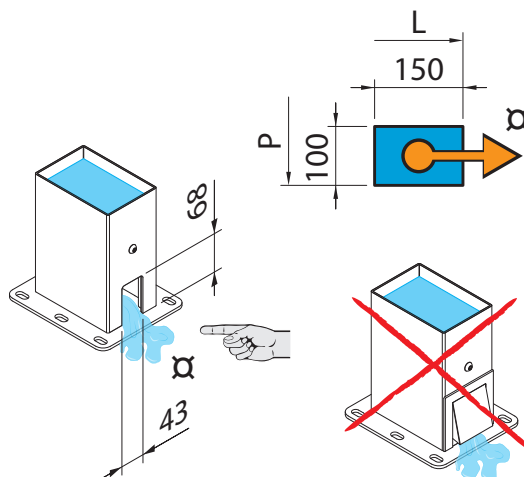
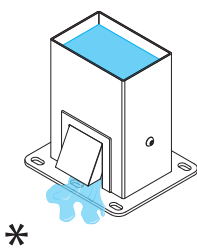
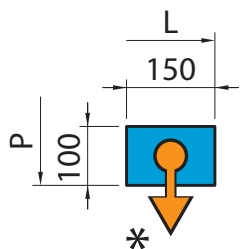
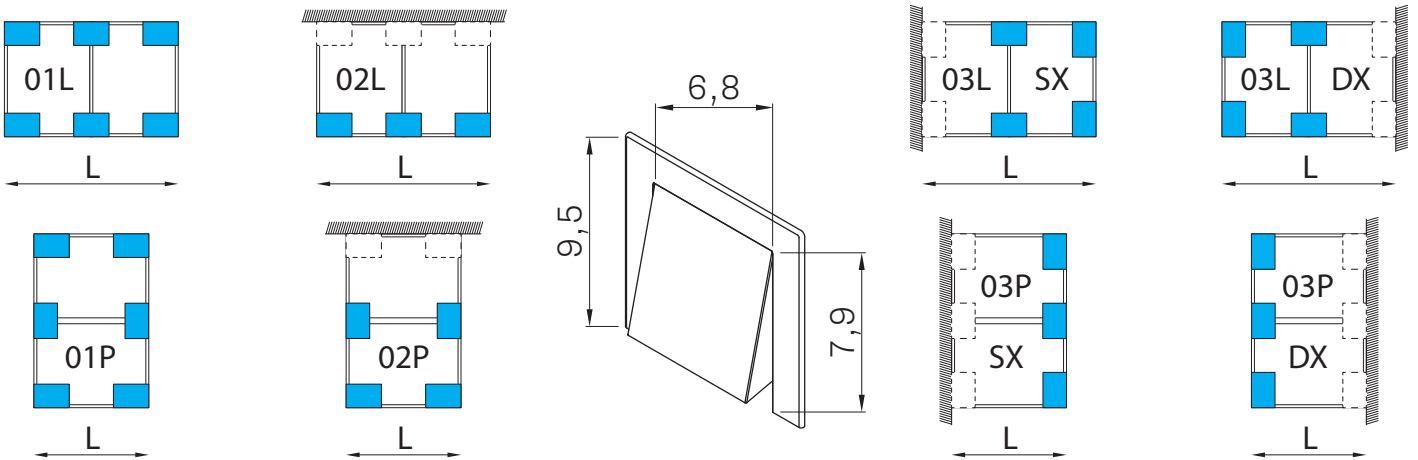
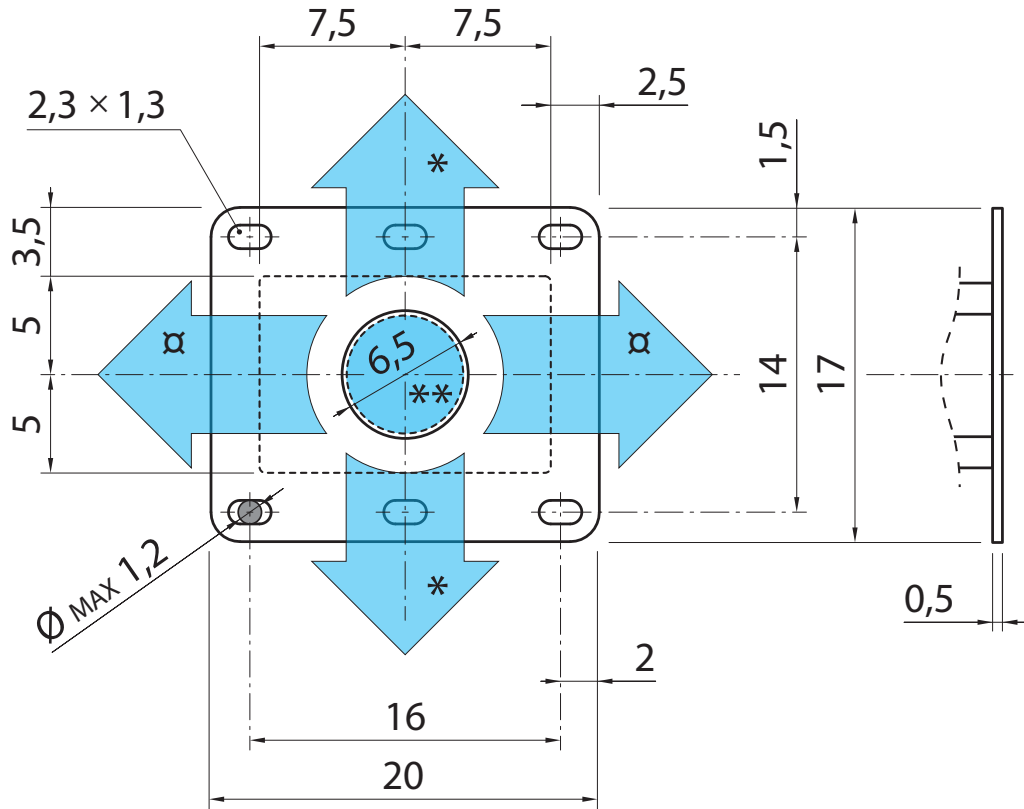



Staffa telescopica (OPT)
Bride télescopique (OPT)

Telescopic bracket (OPT)
Teleskopbügel (OPT)

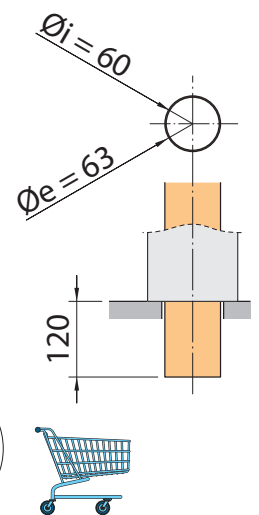
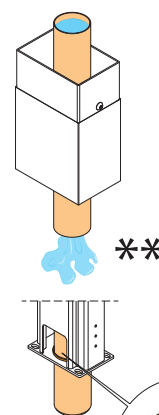
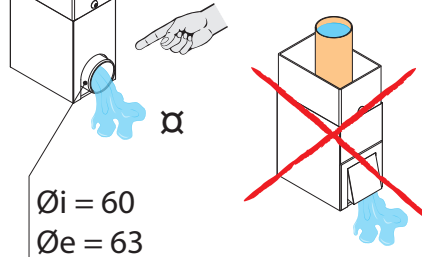
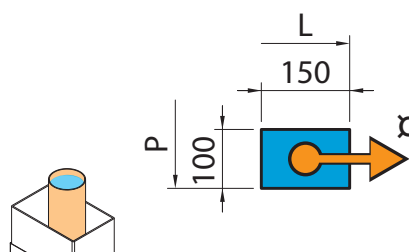
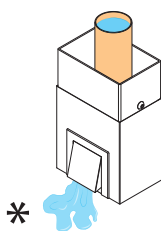
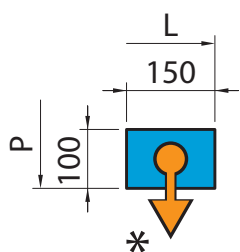
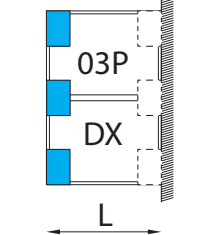
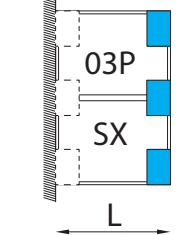
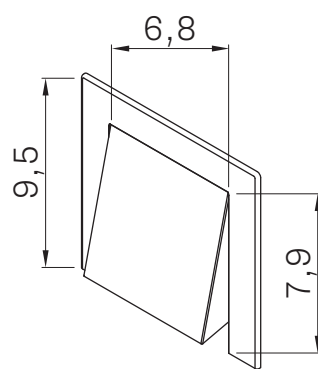
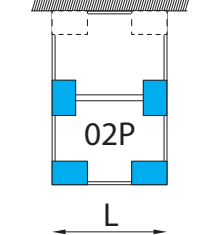
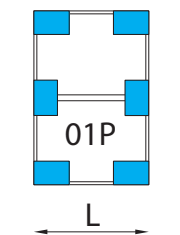
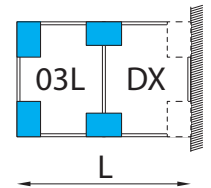
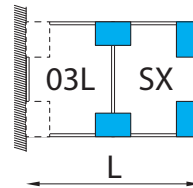
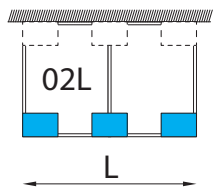
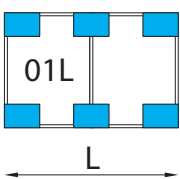
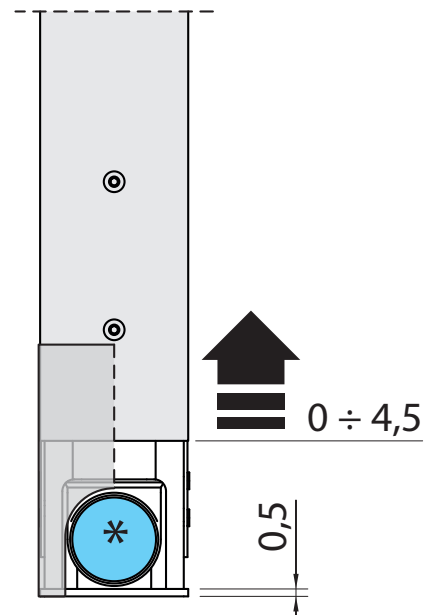
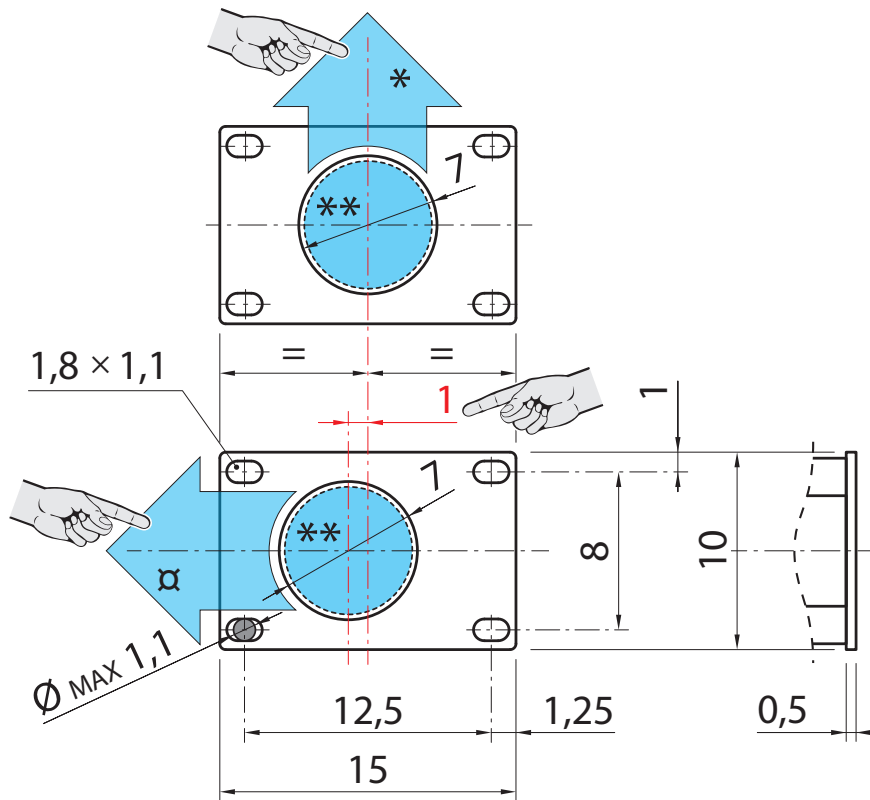

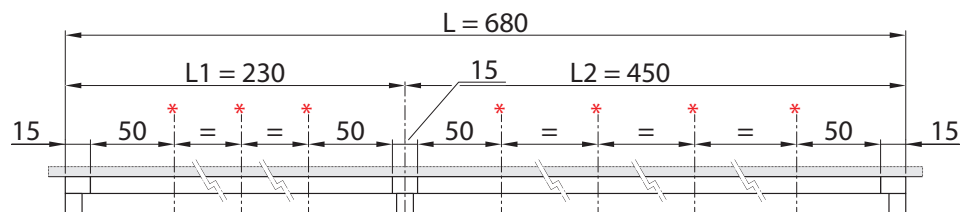
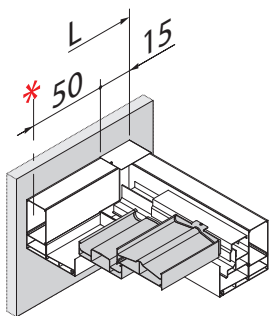
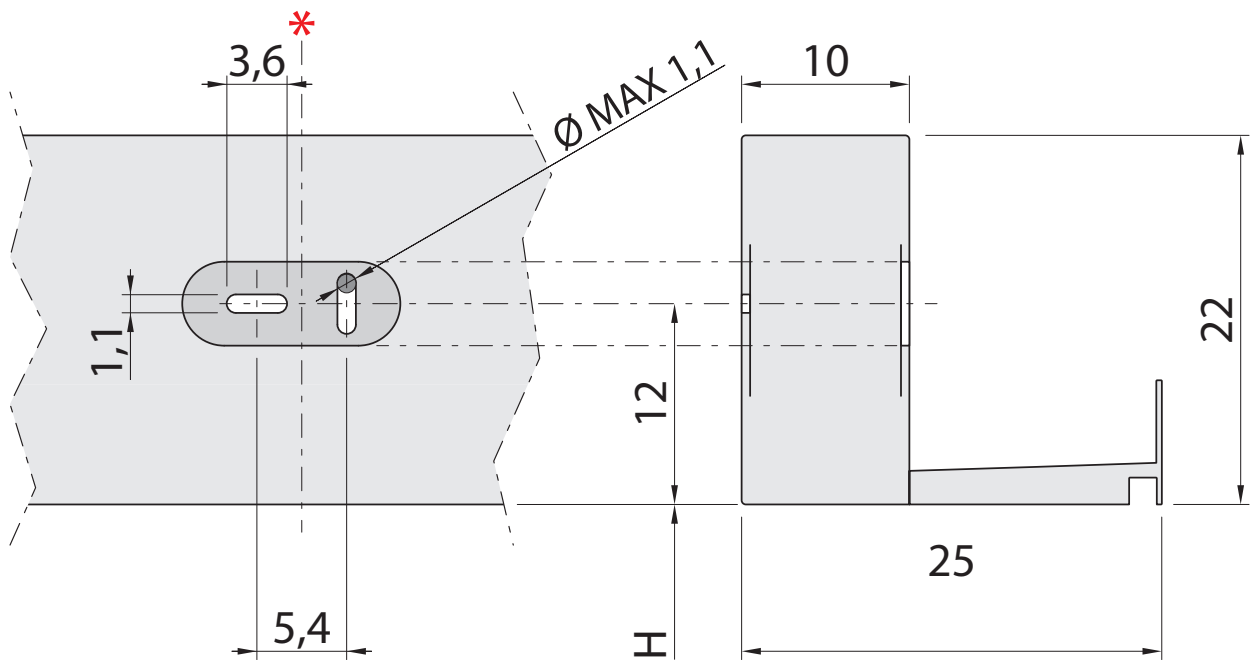

$$L = 680 / L1 = 230 - 15 - 7,5 = 207,5 \quad (3 \times *) / L2 = 450 - 7,5 - 15 = 427,5 \quad (4 \times *)$$

02

DISTRIBUZIONE FISSAGGI A MURO PER OGNI MODULO

2 fissaggi a 50 cm dal bordo esterno del profilo portante.
 Gli altri fissaggi sono distribuiti uniformemente tra i 2 esterni.
 - Profilo con lunghezza inferiore a 4m: 3 fissaggi (*).
 - Profilo con lunghezza inferiore a 5m: 4 fissaggi (*).
 - Profilo con lunghezza superiore o uguale a 5m: 5 fissaggi (*).
 Per fissaggi a quote diverse rivolgersi all'ufficio tecnico.

DISTRIBUTION FIXATIONS AU MUR DE POUR CHAQUE MODULE

2 fixations à 50 cm du bord extérieur du profilé portant.
 Les autres fixations sont réparties uniformément entre les 2 externes.
 - Profil avec longueur inférieure à 4m: 3 fixations (*).
 - Profil avec longueur inférieure à 5m: 4 fixations (*).
 - Profil avec longueur supérieure ou égale à 5m: 5 fixations (*).
 Pour fixations à différentes distances, contactez le bureau technique.

WALL FIXING SPACING FOR EACH MODULE

2 fixings at 50 cm from the external edge of the supporting profile.
 The other fixings are placed uniformly between the 2 external ones.
 - Profile with length of less than 4m: 3 fixings (*).
 - Profile with length of less than 5m: 4 fixings (*).
 - Profile with length equal to/greater than 5m: 5 fixings (*).
 For fixings at different heights please contact the technical department.

VERTEILUNG DER WANDBEFESTIGUNGEN FÜR JEDES MODUL

2 Befestigungen bei 50 cm vom äußeren Rand des Tragprofils.
 Die Anderen sind gleichmäßig zwischen beiden äußeren Modulen verteilt.
 - Profil mit einer Länge kleiner als 4 m: 3 Befestigungen (*).
 - Profil mit einer Länge kleiner als 5 m: 4 Befestigungen (*).
 - Profil mit einer Länge von 5 m oder größer als 5 m: 5 Befestigungen (*).
 Für andere Abstände, wenden Sie sich bitte an das technische Büro.

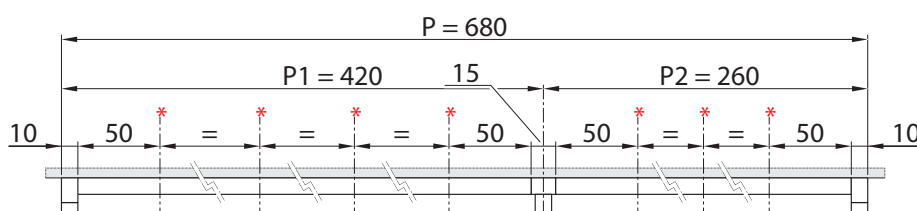
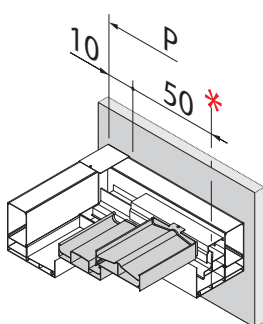
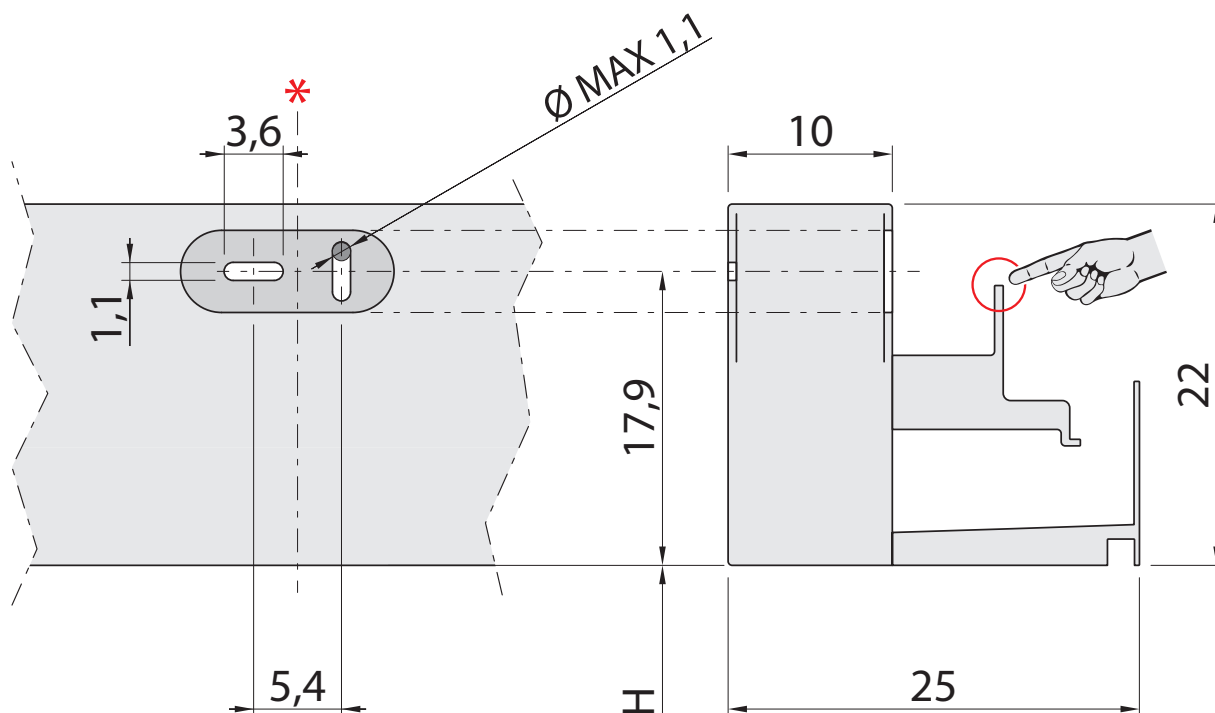

$$P = 680 / P1 = 420 - 10 - 7,5 = 402,5 (4 \times *) / P2 = 260 - 7,5 - 10 = 242,5 (3 \times *)$$

03

DISTRIBUZIONE FISSAGGI A MURO PER OGNI MODULO

2 fissaggi a 50 cm dal bordo esterno del profilo portante.

Gli altri fissaggi sono distribuiti uniformemente tra i 2 esterni.

- Profilo con lunghezza inferiore a 4m: 3 fissaggi (*).
- Profilo con lunghezza inferiore a 5m: 4 fissaggi (*).
- Profilo con lunghezza superiore o uguale a 5m: 5 fissaggi (*).

Per fissaggi a quote diverse rivolgersi all'ufficio tecnico.

DISTRIBUTION FIXATIONS AU MUR DE POUR CHAQUE MODULE

2 fixations à 50 cm du bord extérieur du profilé portant.

Les autres fixations sont réparties uniformément entre les 2 externes.

- Profil avec longueur inférieure à 4m: 3 fixations (*).
- Profil avec longueur inférieure à 5m: 4 fixations (*).
- Profil avec longueur supérieure ou égale à 5m: 5 fixations (*).

Pour fixations à différentes distances, contactez le bureau technique.

WALL FIXING SPACING FOR EACH MODULE

2 fixings at 50 cm from the external edge of the supporting profile.

The other fixings are placed uniformly between the 2 external ones.

- Profile with length of less than 4m: 3 fixings (*).
- Profile with length of less than 5m: 4 fixings (*).
- Profile with length equal to/greater than 5m: 5 fixings (*).

For fixings at different heights please contact the technical department.

VERTEILUNG DER WANDBEFESTIGUNGEN FÜR JEDES MODUL

2 Befestigungen bei 50 cm vom äußeren Rand des Tragprofils.

Die Anderen sind gleichmäßig zwischen beiden äußeren Modulen verteilt.

- Profil mit einer Länge kleiner als 4m: 3 Befestigungen (*).
- Profil mit einer Länge kleiner als 5m: 4 Befestigungen (*).
- Profil mit einer Länge von 5m oder größer als 5m: 5 Befestigungen (*).

Für andere Abstände, wenden Sie sich bitte an das technische Büro.

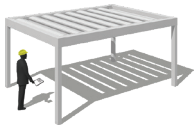

ATTENZIONE: Note importanti prima di procedere al montaggio
ATTENTION: Important notice before starting the installation
ATTENTION: Remarques importantes avant de proceder avec l'assemblage
ANMERKUNG: Allgemeine Hinweise vor Der Montage der Struktur

Scarichi / Discharges / Évacuations / Abläufe

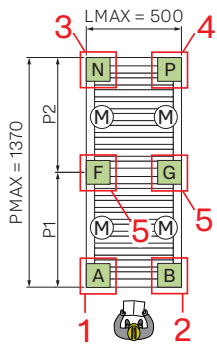
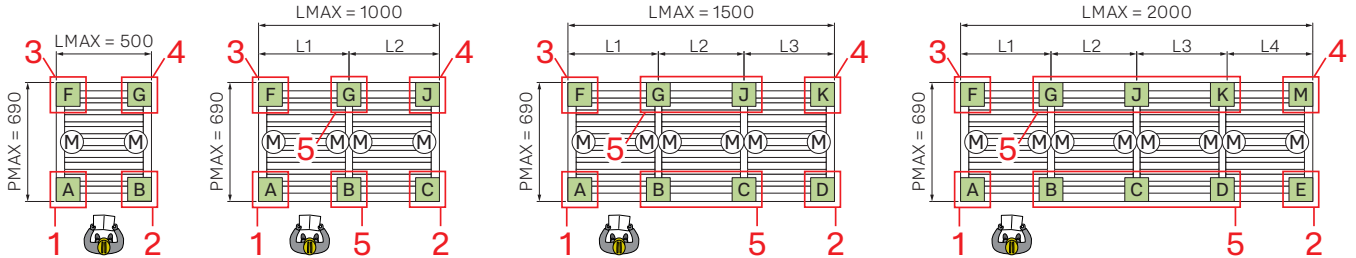

Staffa a terra (Standard)
Bride d'attache au sol (Standard)

Ground bracket (Standard)
Bodenbügel (Standard)

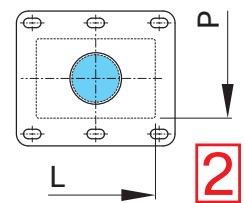
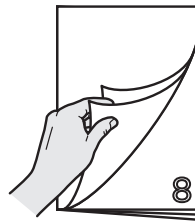
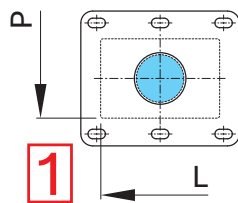
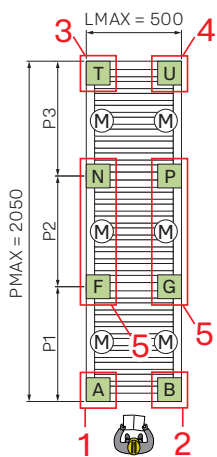
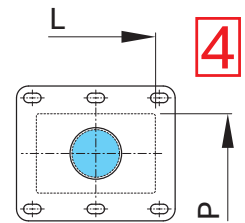
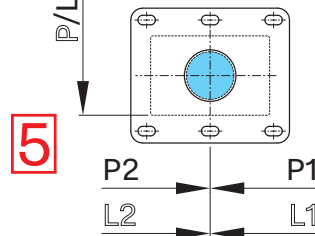
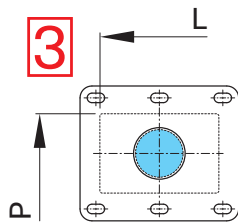

Staffa telescopica (Optional)
Bride télescopique (Optional)

Telescopic bracket (Optional)
Teleskopbügel (Optional)

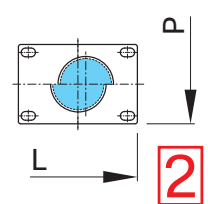
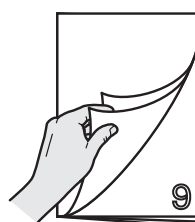
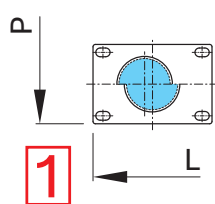
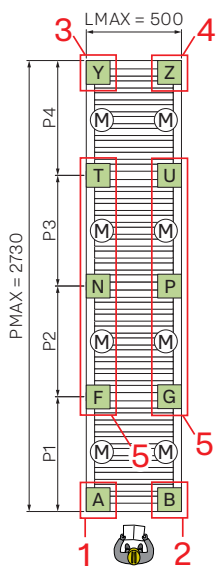
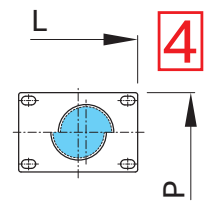
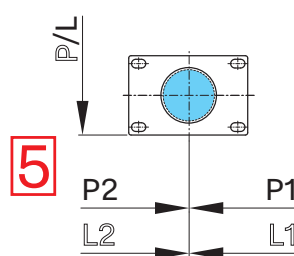
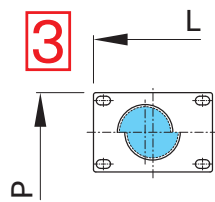



ATTENZIONE:
 ATTENTION:
 ATTENTION:
 ANMERKUNG:

Note importanti prima di procedere al montaggio
 Important notice before starting the installation
 Remarques importantes avant de proceder avec l'assemblage
 Allgemeine Hinweise vor Der Montage der Struktur

Scarichi - Fissaggi / Discharges - Fasteners / Évacuations - Fixations / Abläufe - Befestigungsteile

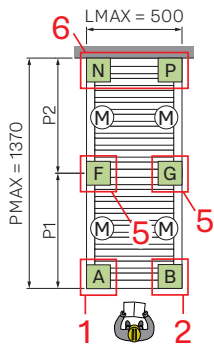
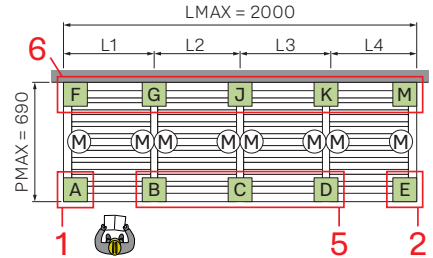
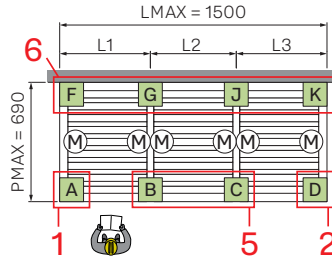
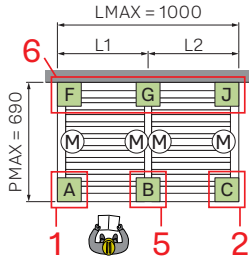
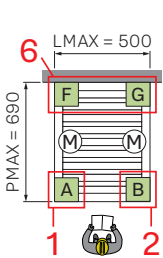

Staffa a terra (Standard)
 Bride d'attache au sol (Standard)

Ground bracket (Standard)
 Bodenbügel (Standard)

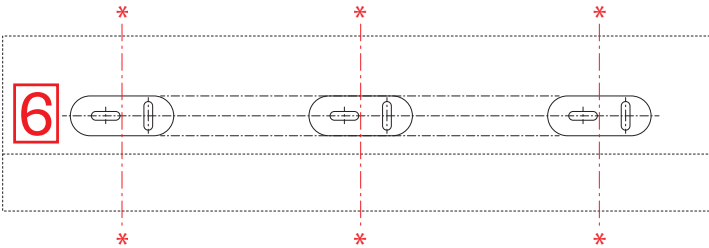

* Posizione variabile
 Variable position
 Distance variable
 Variablen Abstand

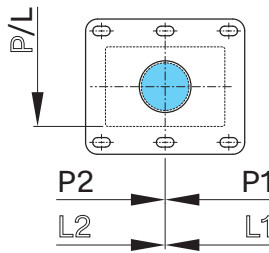
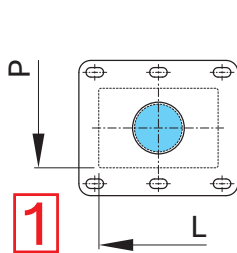
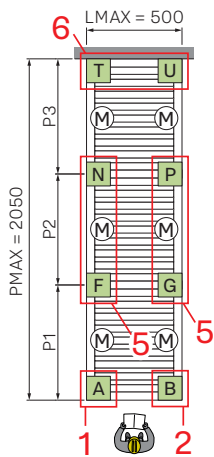

5

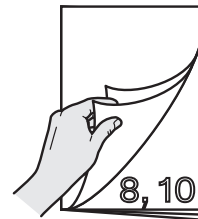

8, 10

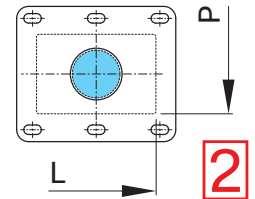

2

Staffa telescopica (Optional)
 Bride télescopique (Optional)

Telescopic bracket (Optional)
 Teleskopbügel (Optional)

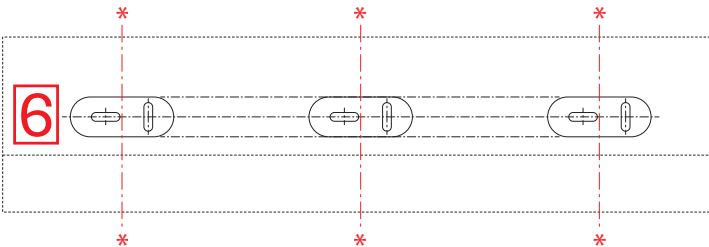

* Posizione variabile
 Variable position
 Distance variable
 Variablen Abstand

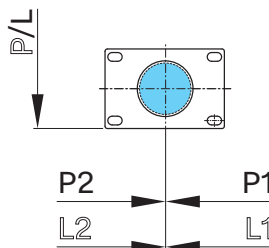
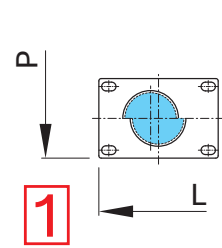
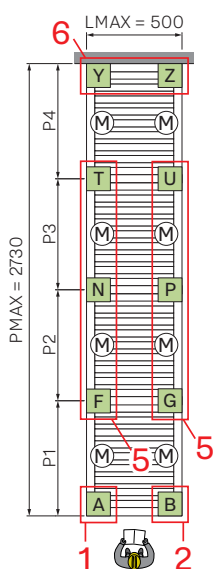

5

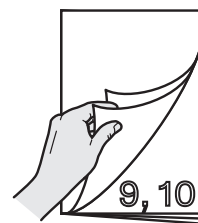

9, 10

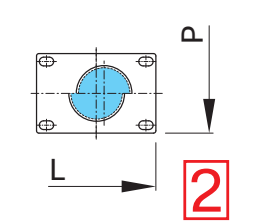

2



ATTENZIONE: NOTE IMPORTANTI PRIMA DI PROCEDERE AL MONTAGGIO
ATTENTION: REMARQUES IMPORTANTES AVANT DE PROCEDER AVEC L'ASSEMBLAGE
ATTENTION: IMPORTANT NOTICE BEFORE STARTING THE INSTALLATION
ANMERKUNG: ALLGEMEINE HINWEISE VOR DER MONTAGE DER STRUKTUR

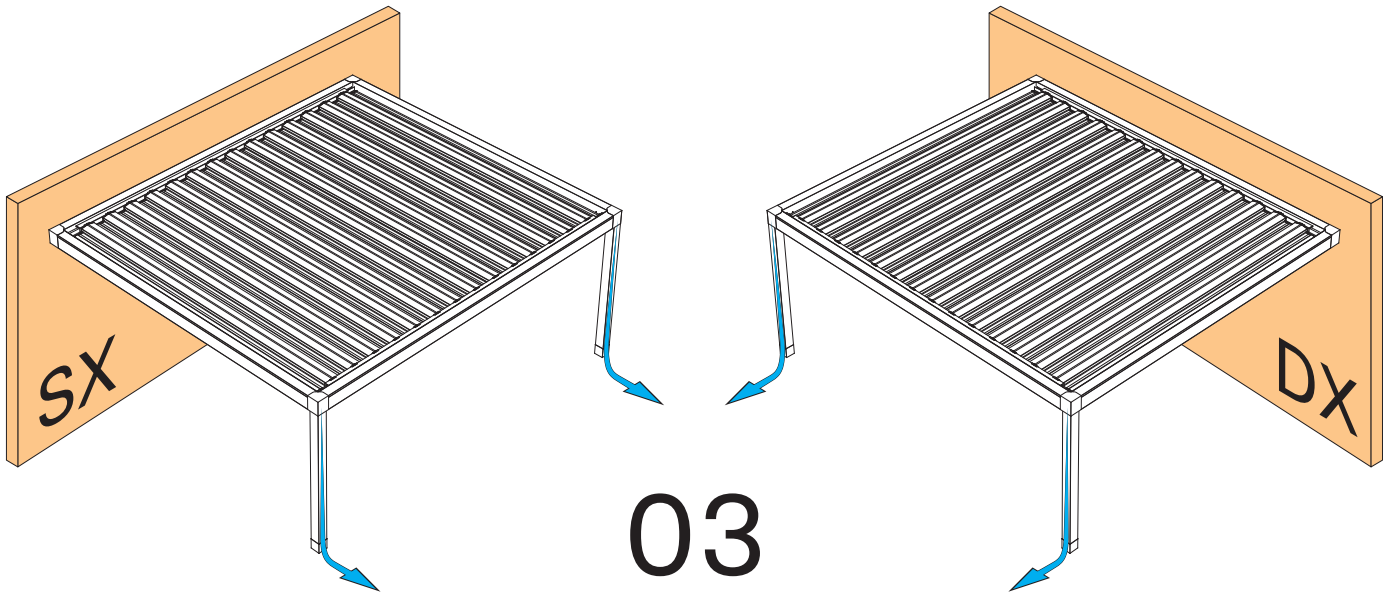

La configurazione con fissaggio 03, ancoraggio a parete lato P (profondità), è soggetta ad una riduzione della portata del corretto drenaggio dell'acqua della copertura, dovuta all'assenza di uno scarico sul lato di connessione a parete, rispetto alle prestazioni del prodotto descritte nella documentazione tecnica.

The fixing configuration 03, wall mounting on side P (depth) is subject to a flow reduction of the correct water drainage of the covering, due to the absence of a water discharge on the side of the wall mounting, compared to the product performance described in the technical files.

La configuration de fixation 03, fixation murale côté P (avancée), est soumise à une réduction de la capacité d'un correct drainage de l'eau de la couverture, en raison de l'absence d'une évacuation sur le côté de fixation murale, par rapport aux performances du produit analysées dans les fiches techniques.

Die Befestigungskonfiguration 03, Wandverankerung Seite P (Tiefe), ist einer Verringerung der Strömung des korrekten Wasserabflusses der Abdeckung unterlegen, aufgrund der Abwesenheit eines Abflusses auf der Seite des Wandanschlusses im Vergleich zu die in der technischen Unterlagen angegebene Produktleistung.



ATTENZIONE:
 ATTENTION:
 ATTENTION:
 ANMERKUNG:

Note importanti prima di procedere al montaggio
 Important notice before starting the installation
 Remarques importantes avant de proceder avec l'assemblage
 Allgemeine Hinweise vor Der Montage der Struktur

Scarichi - Fissaggi / Discharges - Fasteners / Évacuations - Fixations / Abläufe - Befestigungsteile

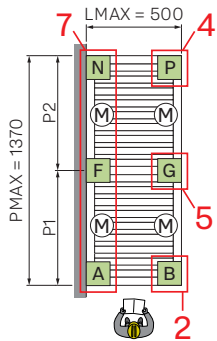
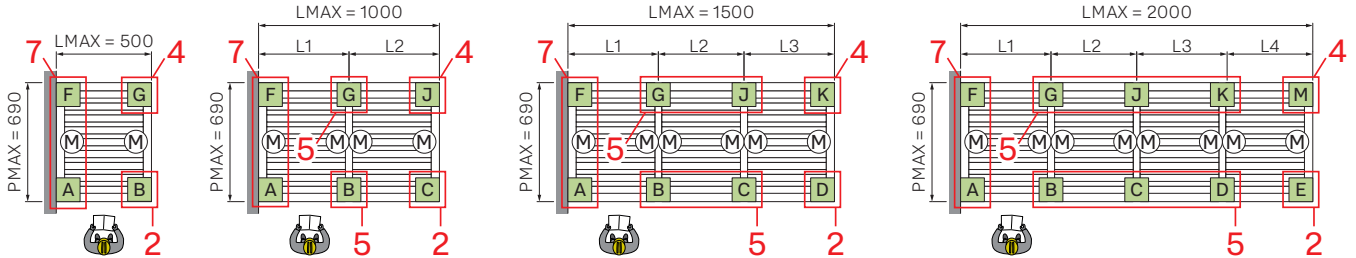

Staffa a terra (Standard)
 Bride d'attache au sol (Standard)

Ground bracket (Standard)
 Bodenbügel (Standard)

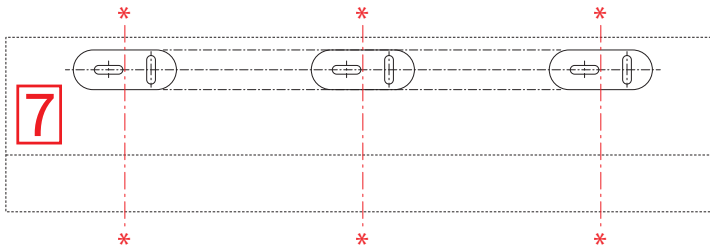

* Posizione variabile
 Variable position
 Distance variable
 Variablen Abstand

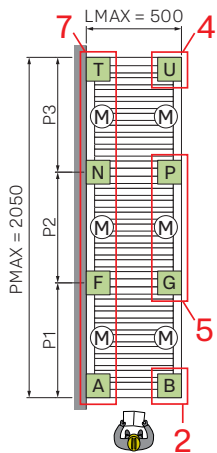

Staffa telescopica (Optional)
 Bride télescopique (Optional)

Telescopic bracket (Optional)
 Teleskopbügel (Optional)

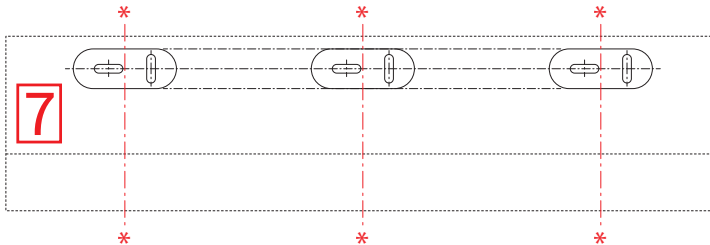

* Posizione variabile
 Variable position
 Distance variable
 Variablen Abstand

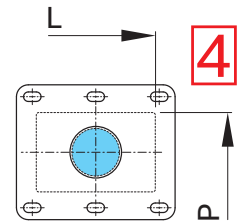
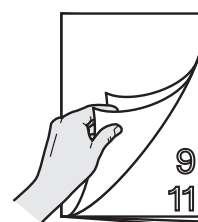
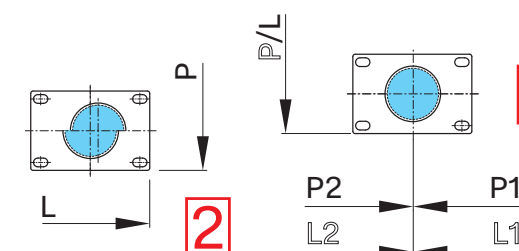
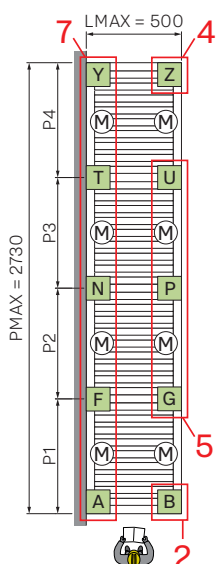



ATTENZIONE:
 ATTENTION:
 ATTENTION:
 ANMERKUNG:

Note importanti prima di procedere al montaggio
 Important notice before starting the installation
 Remarques importantes avant de proceder avec l'assemblage
 Allgemeine Hinweise vor Der Montage der Struktur

Scarichi - Fissaggi / Discharges - Fasteners / Évacuations - Fixations / Abläufe - Befestigungsteile

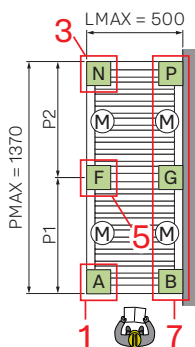
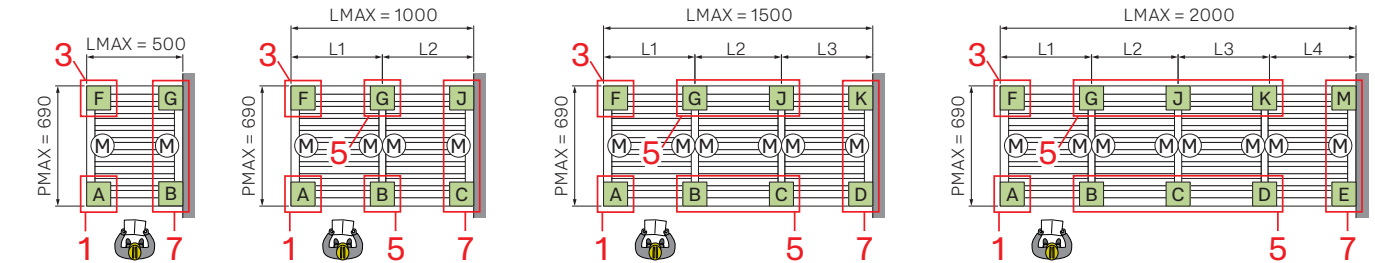

Scarichi acqua frontali e posteriori
 Évacuations de l'eau frontales et postérieures

Front and rear water drainages
 Wasserabflüsse vorne und hinten

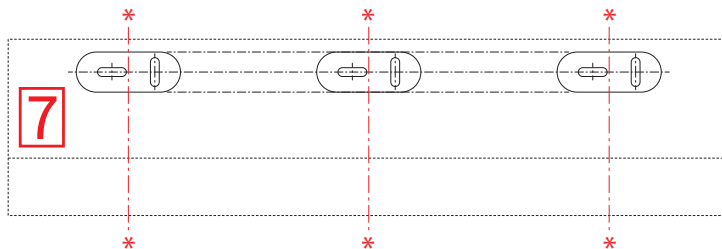

* Posizione variabile
 Variable position
 Distance variable
 Variablen Abstand

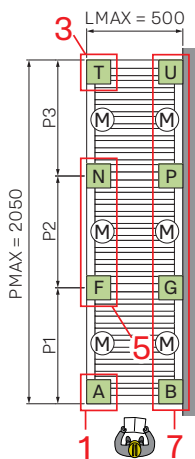

Scarichi acqua laterali
 Évacuations de l'eau latérales

Side water drainages
 Seitliche Wasserabflüsse

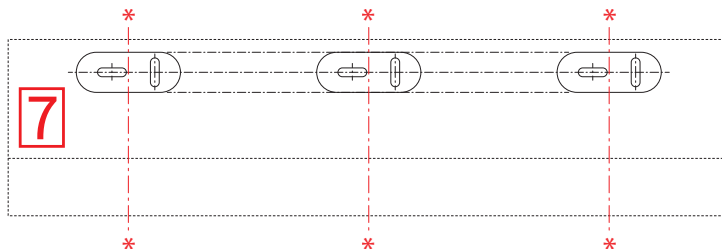

* Posizione variabile
 Variable position
 Distance variable
 Variablen Abstand

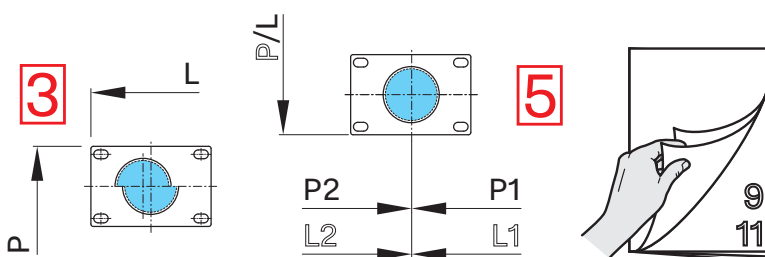
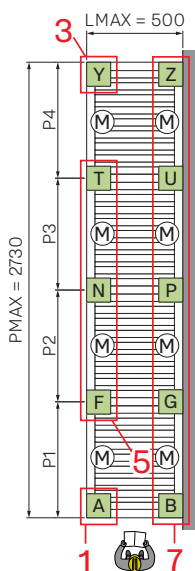



Montaggio senza montanti
Montage sans piliers

Assembly without uprights
Montage ohne Stützen

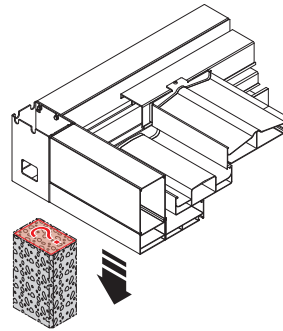

Profilo montante
Post profile
Profilé poteau
Montageprofil
10 × 15

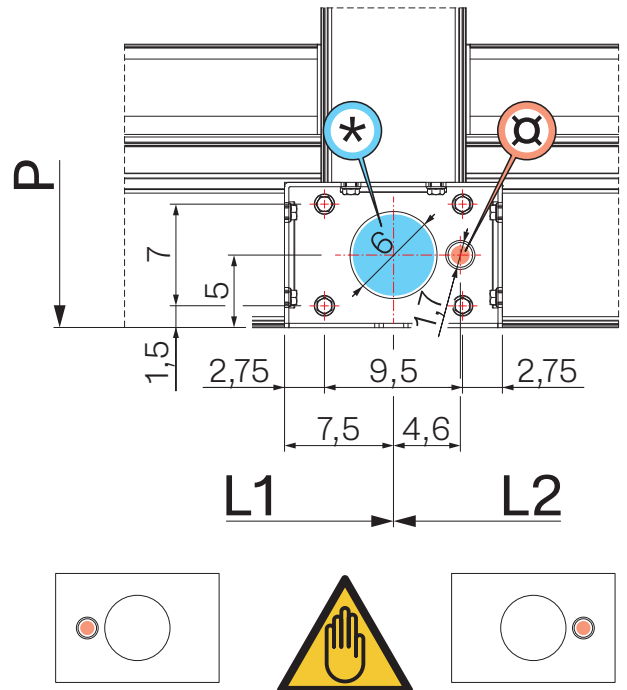
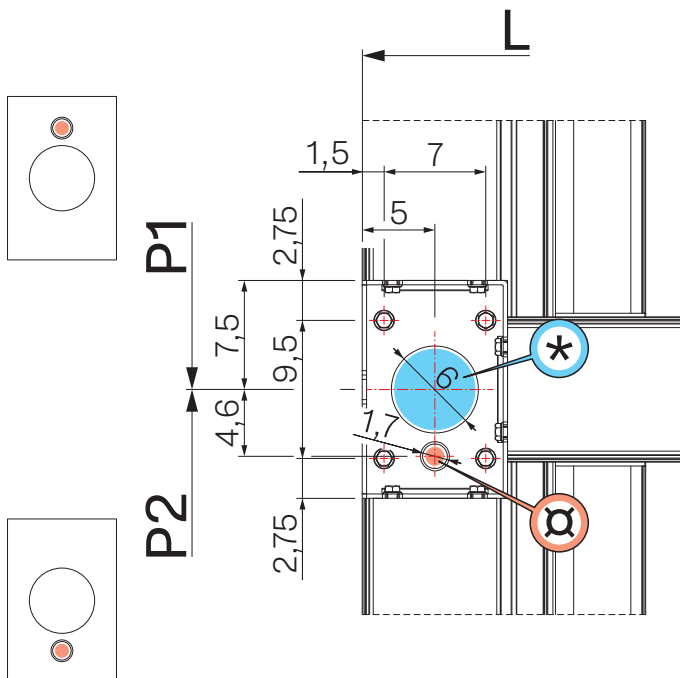
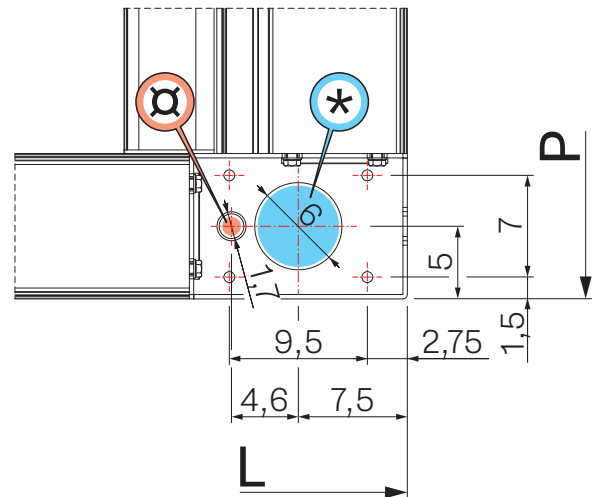
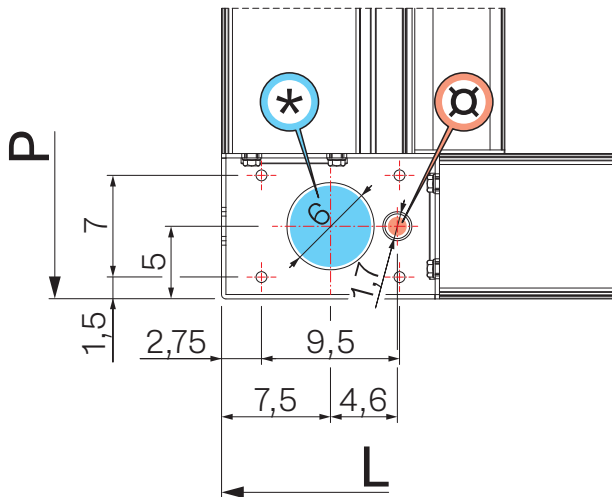

* DEFUSSO ACQUA
WATER DISCHARGE
ÉVACUATION DE L'EAU
WASSERABFLUSS

⚡ ADDUZIONE ELETTRICA
POWER SUPPLY
ALIMENTATION ÉLECTRIQUE
ELEKTROLEITUNG



02 03

ATTENZIONE: non devono essere riversati sulla copertura Pratic qualsiasi scarico di acqua proveniente da pareti verticali o da altre coperture, da tetti, da grondaie, ecc.; questo sovraccaricherebbe il sistema di scarico della copertura riducendo la capacità di drenaggio dell'acqua e potrebbe causare danni a persone, animali o cose.

Per prodotti con scarico acqua convogliato in tubazioni o profili, dimensionare un impianto capace di far defluire l'acqua proveniente dal sistema di scarico del prodotto stesso, evitando strozzature, pendenze inadeguate ed ogni altro impedimento al deflusso e adottando gli appositi accorgimenti per evitare reflussi e diffusione nell'ambiente di odori sgradevoli provenienti dai condotti.

CAUTION: Do not pour on Pratic covering any water drainage coming from vertical walls or from other coverings, roofs, gutters, etc. This would overload the drainage system of the structure, thus reducing the water drainage capability and could cause damages to persons, pets or objects.

For products with water discharge carried in pipes or profiles, set up a system able to drain the water coming from the discharge system, avoiding bottlenecks, inadequate slopes and any other hindrance to the outflow and set up it with special care in order to prevent backflows and diffusion in the environment of unpleasant odors coming from the ducts.

ATTENTION: il est interdit de verser sur le store Pratic les décharges d'eaux venantes de murs verticaux ou d'autres couvertures, avant toits, gouttières, etc.; cela irait surcharger le système de décharge de la couverture, où prévu, réduisant la capacité de drainage de l'eau et pourrait causer dommages aux personnes, animaux ou choses.

Pour les produits avec évacuation de l'eau canalisée dans des tubes ou profils, dimensionner un système capable de faire écouler l'eau provenant du système de décharge, tout en évitant d'étranglements, pentes inadéquates et tout autre empêchement à l'écoulement, et le développer avec les mesures plus appropriées pour éviter tout reflux et la diffusion dans l'endroit d'odeurs désagréables provenant des tuyaux.

ACHTUNG: jeder, aus vertikalen Wänden oder aus anderen Abdeckungen, Dächern, Regenrinnen, usw. kommende Wasserabfluss soll nicht auf die Abdeckung von Pratic ergossen werden; dies könnte das Abflusssystem der Abdeckung überlasten und die Drainagefähigkeit des Wassers reduzieren und könnte Schäden an Personen, Tieren oder Gegenständen verursachen.

Für Produkte mit in Rohren oder Profilen geleitetem Wasserablauf, stellen Sie ein System ein, welches das aus dem Abflusssystem kommende Wasser abfließen lassen kann, indem Engstellen, ungeeignete Neigungen und andere Hindernisse für den Abfluss vermieden werden; stellen Sie es mit besonderer Sorgfalt ein, um Rückflüsse und Diffusion in der Umgebung von, aus den Kanälen kommenden unangenehmen Gerüchen zu verhindern.

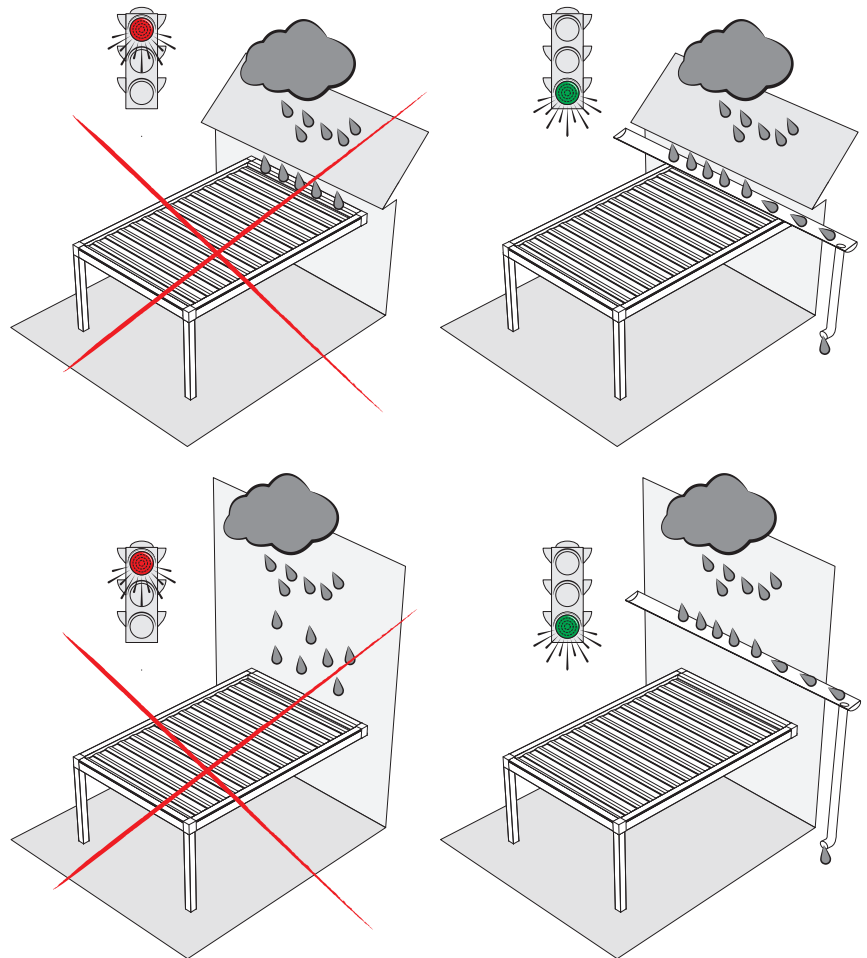



Adduzione elettrica
Alimentation électrique

Power supply
Elektroleitung

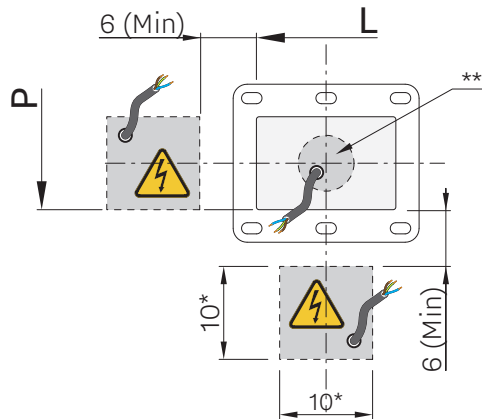

STAFFA A TERRA (STANDARD)
GROUND BRACKET (STANDARD)
BRIDE D'ATTACHE AU SOL (STANDARD)
BODENBÜGEL (STANDARD)

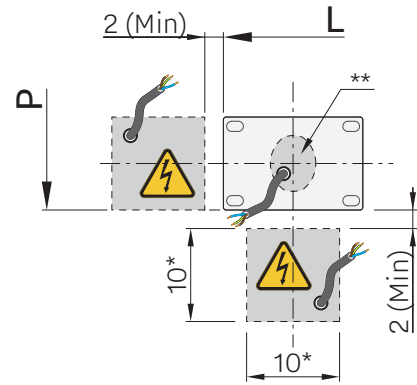

STAFFA TELESCOPICA (OPT)
TELESCOPIC BRACKET (OPT)
BRIDE TÉLESCOPIQUE (OPT)
TELESKOPBÜGEL (OPT)

02

03

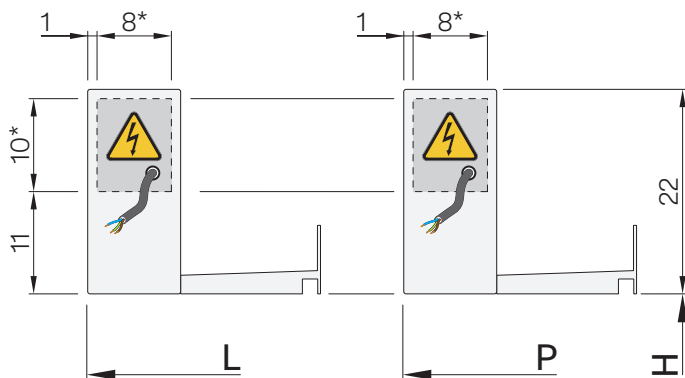

FISSAGGIO A MURO (Profilo Portante Esterno)
WALL MOUNTING (External Supporting Profile)
FIXATION MURALE (Profilé Porteur Externe)
WANDBEFESTIGUNG (Äußeres Tragprofil)

02 03

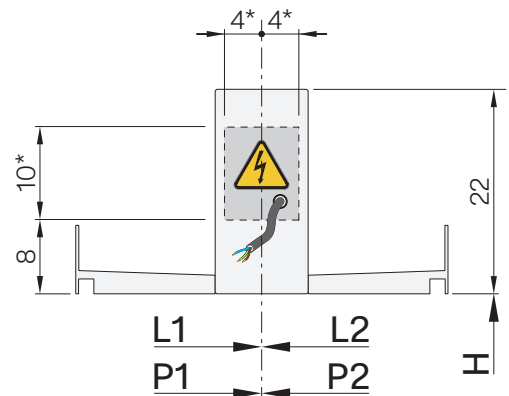

FISSAGGIO A MURO (Profilo Portante Intermedio)
WALL MOUNTING (Intermediate Supporting Profile)
FIXATION MURALE (Profilé Porteur Intermédiaire)
WANDBEFESTIGUNG (Mittleres Tragprofil)

L'ALLACCIAMENTO ELETTRICO PUÒ ESSERE REALIZZATO SU UNO QUALSIASI DEI MONTANTI O DEI FISSAGGI A MURO. QUESTA POSIZIONE DEVE ESSERE SPECIFICATA SUL MODULO D'ORDINE.

(*) QUOTA MASSIMA INDICATIVA DELL'AREA DA CUI FAR USCIRE IL CAVO DI ADDUZIONE ELETTRICA.

(**) UTILIZZANDO IL FORO ALLA BASE DELLA STAFFA A TERRA.

Per il valore di potenza max assorbita (KW) utilizzare il file [Calcolo assorbimenti elettrici... .xlsx](#) (scaricabile dal portale B2B).

THE ELECTRICAL CONNECTION CAN BE MADE ON ANY POST OR WALL FIXING.

THIS POSITION MUST BE SPECIFIED ON THE ORDER FORM.

(*) INDICATIVE MAXIMUM DIMENSION OF THE AREA WHERE THE POWER SUPPLY CABLE CAN BE PLACED.

(**) USING THE HOLE IN THE GROUND BRACKET.

For the maximum power consumption (KW), use the [Electrical absorption calculation... .xlsx](#) file (downloaded from B2B portal).

LE LIEN ÉLECTRIQUE PEUT ÊTRE INSTALLÉ DANS UN DES POTEAUX OU DES FIXATIONS MURALES.

CETTE POSITION DOIT ÊTRE INDIQUÉ DANS LE FORMULAIRE DE COMMANDE.

(*) DIMENSION MAXIMUM DE L'ESPACE DE SORTIE DU CÂBLE DE L'ADDUCTION ÉLECTRIQUE.

(**) IL FAUT UTILISER LE TROU AU FOND DE L' EQUERRE AU SOL.

Pour la valeur de puissance maximale absorbée (KW) utiliser le dossier [Calcul de l'absorption électrique... .xlsx](#), (téléchargeable du portail B2B).

DER ELEKTRONISCHE ANSCHLUSS KANN AUF EINEM DER MONTAGEPROFILE ODER WANDBEFESTIGUNGEN HERGESTELLT WERDEN.

DIESE POSITION MUSS AUF DEM BESTELLFORMULAR ANGEGBEN WERDEN.

(*) MAXIMALE RICHTMASSE DER AUSGANGSFLÄCHE DES STROMVERSORUNGSKABELS.

(**) LOCH DAS AN DER BASIS DES BOGENBÜGELS LIEGT BENUTZEN.

Für den Wert vom maximalen Stromverbrauch (KW), verwenden Sie die [Berechnung des Stromverbrauchs... .xlsx](#) Datei, die Sie vom B2B Portal herunterladen können.

ALIMENTAZIONE ELETTRICA: Il prodotto deve essere collegata ad un impianto elettrico in buone condizioni, conforme alle normative vigenti nel paese di installazione e dotato di impianto di messa a terra funzionante e certificato. Prevedere un interruttore automatico magnetotermico-differenziale di alimentazione dedicato. Il coordinamento tra impianto elettrico dell'edificio, protezione e linea di alimentazione deve essere realizzato da un tecnico abilitato.



COLLEGAMENTO ALLA RETE: I cavi che attraversano una parete metallica devono essere protetti e isolati da una canalina o da una guaina. Fissare i cavi per evitare che entrino in contatto con parti in movimento. Se il prodotto viene utilizzata all'esterno installare il cavo in un condotto resistente ai raggi UV, ad esempio una canalina. Lasciare sempre un anello sul cavo di alimentazione all'esterno per evitare la penetrazione di acqua nel prodotto (**).



PROTEZIONE SCARICHE ATMOSFERICHE: La valutazione del rischio di fulminazione va effettuata da un tecnico abilitato che, applicando la normativa vigente nel paese di installazione del prodotto, può determinare se la struttura, in riferimento alla sua posizione di installazione ed al suo ambiente circostante, necessita di protezioni contro le scariche atmosferiche. A protezione delle apparecchiature elettroniche installate sui prodotti, valutare l'installazione di appositi scaricatori di sovratensione. Gli scaricatori vanno dimensionati da un tecnico abilitato in funzione del tipo di impianto di alimentazione elettrica a monte della struttura.

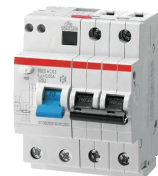

POWER SUPPLY: The product must be connected to a fully functional electrical system, in accordance with the regulations in force in the destination country and equipped with a functional and certified earthing system. Please provide for a dedicated automatic, thermomagnetic earth leakage circuit breaker. The organization of the electrical system of the building, protective measures and supply line must be carried out by a qualified technician.



NETWORK CONNECTION: All cables going through a metal wall must be protected and insulated with a cable duct or a cable pipe. Fix the cables to prevent them from touching moving parts. If the product is located outdoors, place the cable in a UV-rays resistant duct, such as a cable duct. Always leave a loop on the external part of the supply cable in order to avoid any water infiltration inside the product (**).

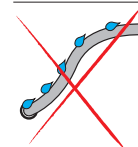

CAUTION: PROTECTION AGAINST LIGHTNING: The evaluation of the risk of lightning strike must be carried out by a competent technician who, in compliance with the regulations in force in the country of installation of the product, must decide whether the structure, in consideration of the installation position and surrounding environment, needs protection devices against lightning. To protect the electronic equipment installed on the products, it is necessary to take into consideration the use of specific lightning arresters. Arresters must be adapted by a competent technician according to the type of power supply system of the structure.

ALIMENTATION ÉLECTRIQUE: Le produit doit être connecté à un système électrique dans de bonnes conditions, conforme à la réglementation en vigueur dans le pays d'installation et équipé d'un système de mise à terre, qui fonctionne et qui est certifié. Prévoir un disjoncteur automatique magnétothermique-différentiel d'alimentation dédiée. La coordination entre le système électrique du bâtiment, la protection et la ligne d'alimentation doit être effectuée par un technicien qualifié.

CONNEXION AU RÉSEAU: les câbles qui traversent un mur métallique doivent être protégés et isolés par une conduite ou un gainage. Fixez les câbles pour éviter qu'ils entrent en contact avec des pièces mobiles. Si le produit est utilisé à l'extérieur, installez le câble dans un conduit résistant aux rayons UV, tel qu'une conduite. Laissez toujours une boucle sur le câble d'alimentation à l'extérieur pour empêcher l'entrée d'eau dans le produit (**).

PROTECTION DÉCHARGES ATMOSPHÉRIQUES: L'évaluation des risques de foudre doit être effectuée par un technicien qualifié que par l'application de la législation en vigueur dans le pays d'installation du produit, peut déterminer si la structure, en référence à sa position d'installation et à son environnement, a besoin des protections contre la foudre. A' protection des équipements électroniques installés sur les produits, évaluer l'installation de parafoudres de surtension spéciaux. Les parafoudres doivent être dimensionnés par un technicien qualifié en fonction du type de système d'alimentation électrique en amont de la structure.

STROMVERSORGUNG: Das Produkt muss mit einer in gutem Zustand Elektroanlage verbunden sein, gemäß den im Installationsland geltenden Bestimmungen und soll mit funktionstüchtiger und zertifizierter Erdungsanlage ausgestattet sein. Stellen Sie einen gewidmeten, automatischen, magnetothermischen FI-Schutzschalter zur Versorgung. Die Koordination von Elektroanlage des Gebäudes, Schutz und Speiseleitung soll von einem qualifizierten Techniker ausgeführt werden.

VERBINDUNG ZUM NETZWERK: Die Kabel, die durch eine Metallwand verlaufen, sollen mit einem Kabelkanal oder mit einem Kabelschlauch geschützt und isoliert werden. Befestigen Sie die Kabel, um den Kontakt mit beweglichen Teilen zu vermeiden. Wenn das Produkt im Freien verwendet wird, verlegen Sie das Kabel in einem UV-widerstandsfähigen Rohr, bzw. in einem Kabelkanal. Lassen Sie immer eine Schlaufe auf dem Netzkabel auf der Außenseite, um das Wassereindringen in dem Produkt zu verhindern (**).

BLITZSCHUTZ: Die Abschätzung des Risikos vom Blitz muss von einem Fachtechniker ausgeführt werden. Durch die Handhabung der geltenden Rechtsvorschriften im Land der Installation des Produktes, kann er bestimmen, ob die Struktur, in Bezug auf den Installationsort und auf das umliegende Gebiet, den Schutz vor den Blitzen erfordert. Zum Schutz der auf den Produkten installierten elektronischen Geräten, schätzen Sie die Installation geeigneter Überspannungsableiter ein. Die Ableiter sollen von einem Fachtechniker angepasst werden, abhängig von der Art der Stromversorgungsanlage der Struktur.

OPT

Con profilo angolare di sostegno
Avec profil angulaire de support

With supporting angle profile
Mit Eckprofil zur Abstützung

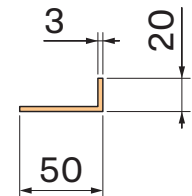
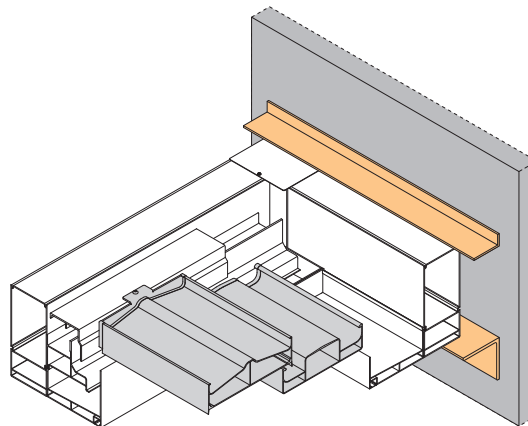
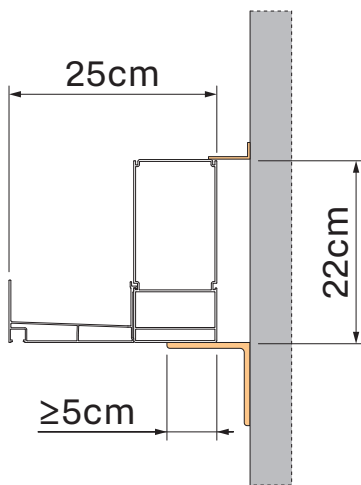
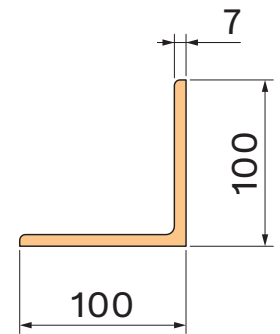
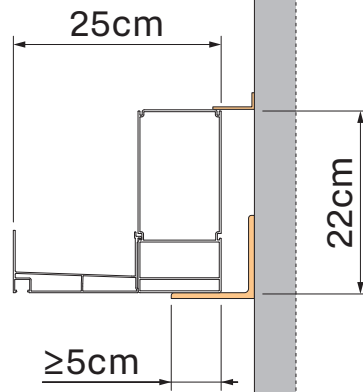
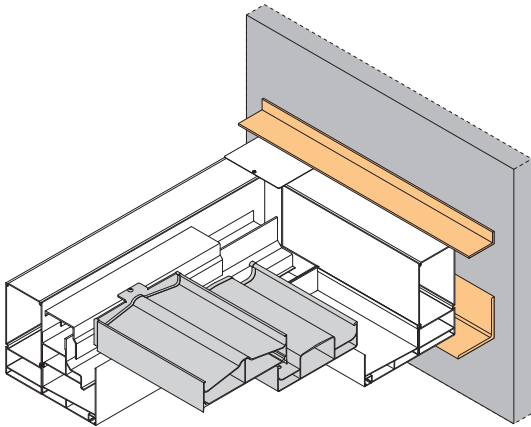

ATTENZIONE: SEZIONI MINIME SUGGERITE

[PROFILI NON FORNITI
[APPROVVIGIONAMENTO DA PARTE DELL'INSTALLATORE]

Soluzione suggerita in presenza di pareti non piane, non a squadro,
con superficie irregolare, senza aderenza tra parete e struttura.

WARNING: MINIMUM SECTION SUGGESTED

[PROFILES NOT SUPPLIED
[BUT RATHER BY THE INSTALLER]

Suggested solution in case of not flat, not straight or with non-regular
surfaced walls, without adherence between wall and structure.

ATTENTION: SECTIONS MINIMALES SUGGÉRÉES

[PROFILS NON FOURNIS
[MAIS PAR L'INSTALLATEUR LUI-MÊME]

Solution proposée en présence de parois non planes, non à angle droit,
avec surface irrégulière, sans adhérence entre parois et structure.

ACHTUNG!: VORGESCHLAGENE NIEDRIGSTE STÜCKE

[PROFILE WERDEN NICHT GELIEFERT
[SONDERN VOM INSTALLATEUR SELBST]

Vorgeschlagene Lösung in Anwesenheit von nicht ebenen, nicht rechtwinkligen
Wänden, mit unebener Oberfläche, ohne Haftung zwischen Wand und Struktur.



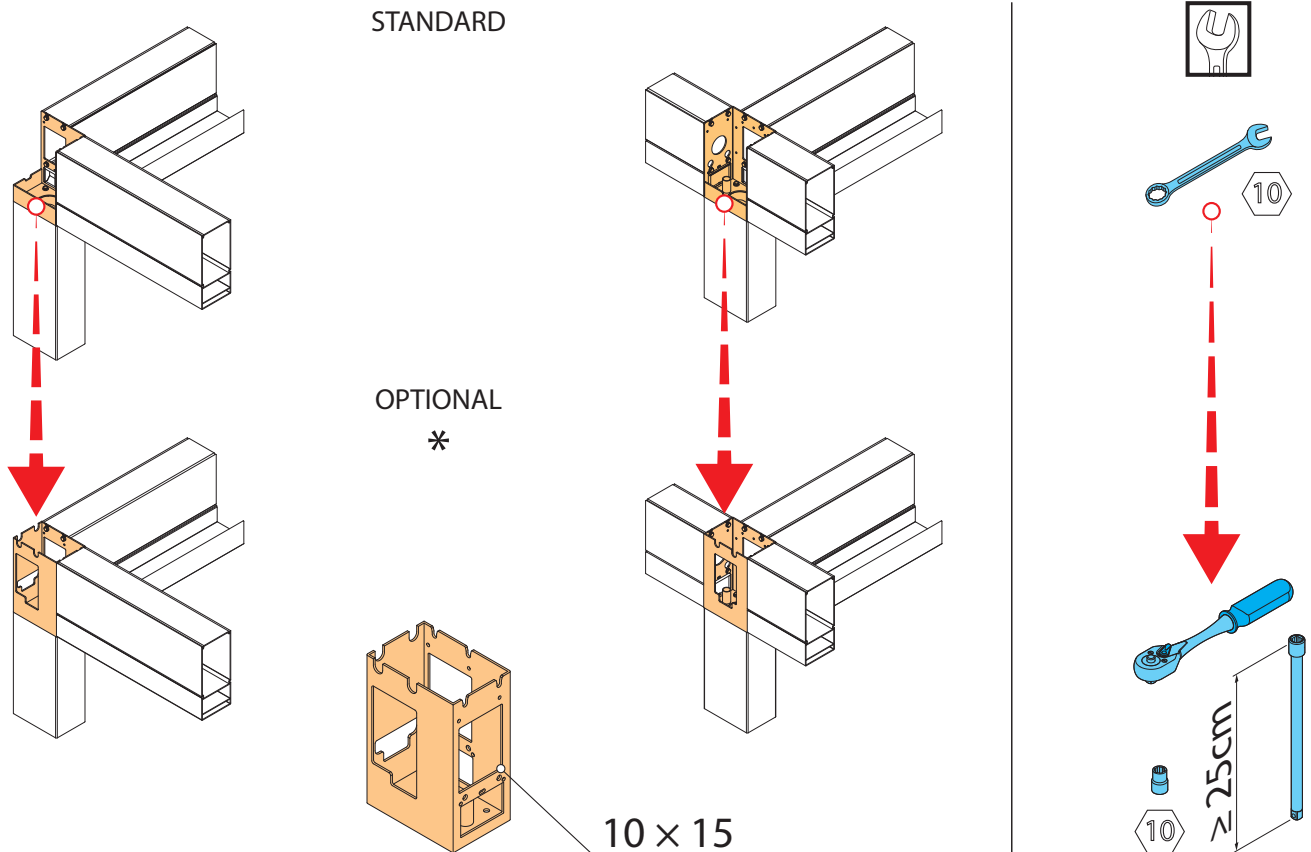

(*) STAFFE GIUNZIONI PERIMETRALI CON LATI CHIUSI - OPTIONAL (per GLASS SERIES)

(Per l'installazione ove il luogo di posa è particolarmente soggetto all'azione del vento, quali ad esempio zone di mare, vallate, piani rialzati, ecc. - da richiedere in fase di compilazione ordine).

Nel caso di Pergolas abbinate a Glass Series: le ante scorrevoli, anche se impacchettate, offrono una superficie maggiore alla spinta del vento. Valutare la compatibilità della resistenza al vento del prodotto (Consultare i dati di resistenza al vento presenti nel fascicolo tecnico del produttore) comprensiva dei prodotti complementari abbinati (es. tende a caduta, serramenti, ecc.), con i requisiti minimi del sito di posa.

(*) PERIMETER JUNCTION BRACKETS WITH CLOSED SIDES - OPTIONAL (for GLASS SERIES)

(In case of installations where the installation site is particularly subject to wind, such as sea areas, valleys, raised floors, etc. - to be required while filling in the order).

In case of Pergolas combined with Glass Series: the sliding closures, even if packaged, offer a greater surface to wind pressure. Please take into consideration the compatibility of the product wind resistance (please refer to the wind resistance data contained in the manufacturer's technical manual) including the connected accessories (e.g. drop-down awnings, windows, etc.), with the minimum requirements of the installation site.

(*) BRIDES DE JONCTION PERIMETRIQUES AVEC COTES FERMES - OPTIONAL (pour GLASS SERIES)

(Pour l'installation où le lieu de pose est particulièrement exposé à l'action du vent, comme par exemple des zones maritimes, vallées, rez-de-chaussée surélevés, etc. - à demander en cours de remplissage du bon de commande).

Dans le cas de Pergolas associés à Glass Series: les fermetures coulissantes, même repliées, offrent une plus grande surface à la poussée du vent. Évaluer la compatibilité de la résistance au vent du produit (consulter les données de résistance au vent dans le dossier technique du producteur) en tenant compte des accessoires complémentaires associés (p.ex. stores verticaux, huisseries etc.), par rapport aux conditions minimales requises du lieu de pose.

(*) UMLAUFENDE VERBINDUNGSBÜGEL MIT GESCHLOSSENEN SEITEN - OPTIONAL (Für GLASS SERIES)

(Bei Installationen, wo der Aufstellungsort dem Wind unterliegt, wie z.B. Meeresbereiche, Täler, erhobene Böden usw. - bitte beim Ausfüllen des Bestellformulars anfordern).

Bei Pergolas in Kombination mit Glass Series: die verglasten Schiebeschließungen bieten, auch wenn sie paketiert sind, eine größere Oberfläche bei Winddruck. Berücksichtigen Sie die Kompatibilität des Windwiderstands des Produkts (sehen Sie die Windwiderstandsdaten in den technischen Unterlagen des Herstellers ein), einschließlich der verbundenen Zubehörteile (z.B. Fallmarkisen, Fenster, usw.), mit den Mindestanforderungen des Aufstellungsorts.

